

TEKTRONIX®



7A19
AMPLIFIER

INSTRUCTION MANUAL

Tektronix, Inc.
P.O. Box 500
Beaverton, Oregon 97077

Serial Number _____

070-2129-00

First Printing MAY 1976

WARRANTY

All TEKTRONIX instruments are warranted against defective materials and workmanship for one year. Any questions with respect to the warranty should be taken up with your TEKTRONIX Field Engineer or representative.

All requests for repairs and replacement parts should be directed to the TEKTRONIX Field Office or representative in your area. This will assure you the fastest possible service. Please include the instrument Type Number or Part Number and Serial Number with all requests for parts or service.

Specifications and price change privileges reserved.

Copyright © 1972, new material copyright 1976, by Tektronix, Inc., Beaverton, Oregon. Printed in the United States of America. All rights reserved. Contents of this publication may not be reproduced in any form without permission of Tektronix, Inc.

U.S.A. and Foreign TEKTRONIX products covered by U.S. and foreign patents and/or patents pending.

TEKTRONIX is a registered trademark of Tektronix, Inc.

TABLE OF CONTENTS

	Page
SECTION 1 SPECIFICATION	
Introduction	1-1
Option 4	1-1
SECTION 2 OPERATING INSTRUCTIONS	
Front Panel Controls and Connectors	2-1
Operating Instructions and Checkout	2-1
Applications	2-2
SECTION 3 CIRCUIT DESCRIPTION	
Block Diagram	3-1
Detailed Circuit Description	3-1
SECTION 4 MAINTENANCE	
Preventive Maintenance	4-1
Troubleshooting	4-1
Corrective Maintenance	4-3
SECTION 5 CALIBRATION	
Performance Check	5-1
Test Equipment Required	5-1
Calibration Procedure	5-3
Index to Calibration Procedure	5-4
SECTION 6 ELECTRICAL PARTS LIST	
SECTION 7 DIAGRAMS	
Circuit Board Illustrations	
Semiconductor Electrode Configurations	
SECTION 8 MECHANICAL PARTS LIST	
Exploded View Drawing	
CHANGE INFORMATION	

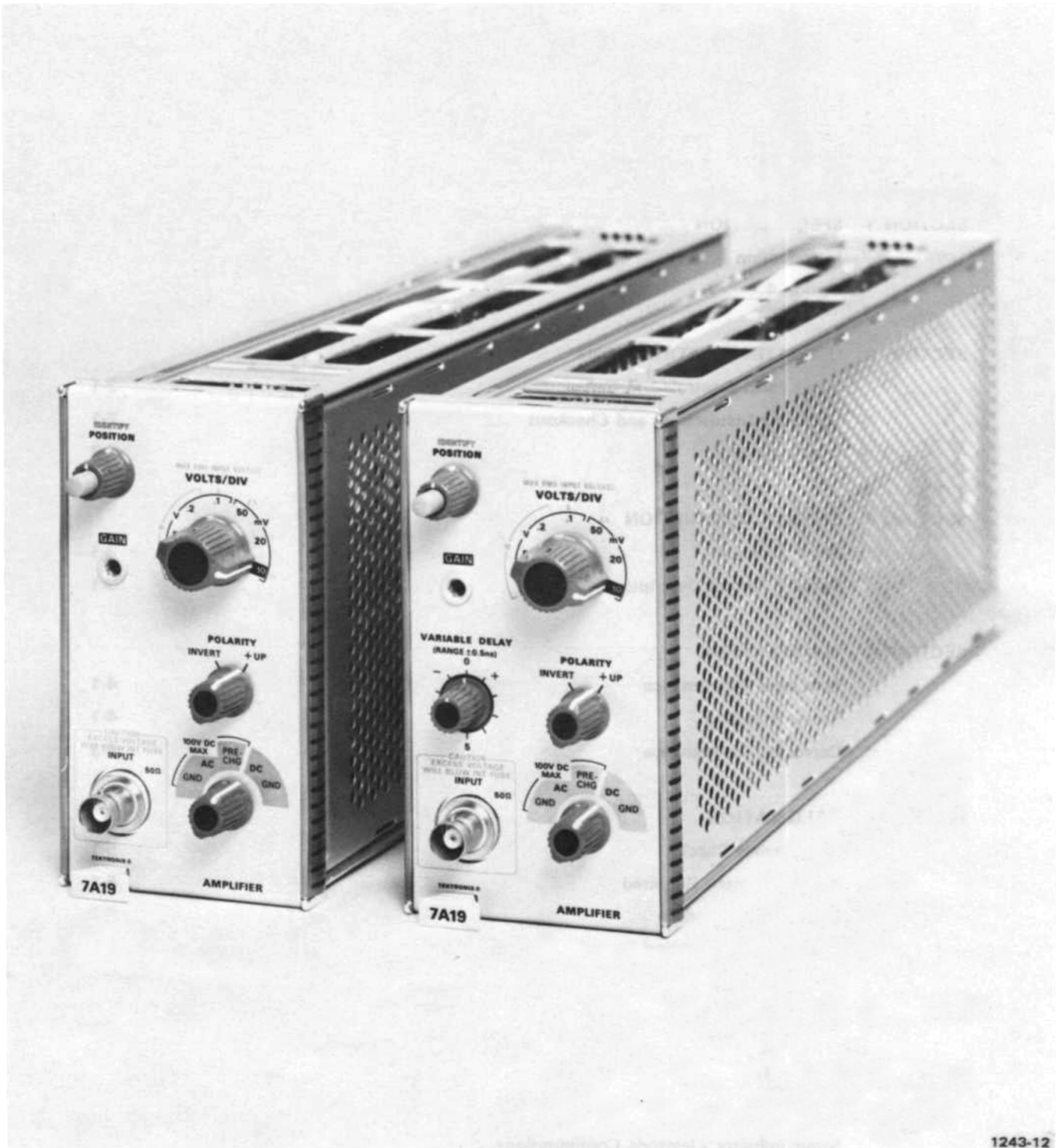

Fig. 1-1. 7A19 Amplifier plug-in (Left) and 7A19 with Variable delay option (Right).

SPECIFICATION

Introduction

The 7A19 Amplifier plug-in unit is a wide band amplifier designed for use with TEKTRONIX 7000-Series oscilloscopes. Readout encoding circuitry is provided in the 7A19 to allow probe coding, deflection factor readout, and IDENTIFY functions. The 7A19 can be operated in any compartment of the 7000-Series oscilloscopes, but is primarily intended for use in the vertical plug-in compartments.

The following electrical characteristics are valid over the stated environmental range for instruments calibrated at an ambient temperature of +20°C to +30°C, and after a five minute warmup unless otherwise noted.

Option 4

An optional VARIABLE DELAY may be ordered with the 7A19 to provide a signal delay of up to ± 500 ps.

TABLE 1-1
ELECTRICAL

Characteristic	Performance Requirement	Supplemental Information
Deflection Factor Calibrated Range	10 mV/div to 1 V/div, 7 steps in a 1, 2, 5 sequence	Pre-Charge circuit may be used as a calibrated 100X attenuator
Gain Ratio Accuracy	Within 3% with GAIN adjusted at 10 mV/div when driven from 50 ohm source.	Front panel GAIN control allows calibration to mainframe.
Frequency Response (8 division reference, mainframe dependent) Upper Bandwidth AC or DC coupled 10 mV/div to 1 V/div Lower Bandwidth AC Coupled	With 7400, 65 MHz; With 7500, 100 MHz; With 7700, 175 MHz; With 7900, 500 MHz 1 kHz or less	
Maximum Input Power DC or AC coupled Voltage (AC coupled)	2 watts average or 50 divisions peak deflection. 100 volts (DC + peak AC) not to exceed 2 watts average or 50 divisions peak.	CAUTION <i>Pre-charge circuit must be used for both charging and discharging AC coupling capacitor to potentials greater than 50 divisions equivalent voltage.</i>
Input Impedance Resistance (DC or DC GND) Reflection Coefficient (Time Domain)	50 ohms ± 1 ohm Less than 0.1 peak to peak	VSWR is typically less than 1.25 @ 500 MHz
Maximum Input Current	Less than 0.2 mA	

TABLE 1-1 (cont)

Characteristic	Performance Requirement	Supplemental Information
IDENTIFY		Deflects trace approximately 0.3 division
Trace Positioning		At least ±8 divisions
Display Noise (Tangentially Measured)		Less than 0.1 division
DC Drift Drift with ambient temperature (line voltage constant)	100 $\mu\text{V}/\text{C}^\circ$ or less	
Variable Delay (Option 4) Range Accuracy	Variable from -0.5 ns to +0.5 ns To 1 ns within ±0.05 ns of dial setting	
Input Polarity		Front panel switch selects +UP or INVERT

TABLE 1-2

ENVIRONMENTAL CHARACTERISTICS

Refer to the specifications for the associated oscilloscope.

TABLE 1-3

PHYSICAL

Size	Fits all 7000-Series plug-in compartments
Weight	7A19: .9 kilograms or 2.1 lbs. 7A19 (option 1): 1.3 kilograms or 2.9 lbs.

OPERATING INSTRUCTIONS

General

To effectively use the 7A19, the operation and capabilities of the instrument must be known. This section describes front-panel control functions, general information on signal input connections, and other subjects that pertain to various measurement applications.

Installation

The 7A19 is calibrated and ready for use as received. It can be installed in any compartment of TEKTRONIX 7000-Series Oscilloscopes, but is intended for principal use in vertical plug-in compartments. To install, align the upper and lower rails of the 7A19 with the oscilloscope tracks and insert it. The front panel will be flush with the front of the oscilloscope and the latch at the bottom left corner will be in place against the front panel when the 7A19 is fully inserted.

To remove the 7A19, pull on the latch (inscribed with the unit identification "7A19") and the 7A19 will unlatch. Continue pulling to slide the 7A19 out of the oscilloscope.

FRONT PANEL CONTROLS AND CONNECTORS

VOLTS/DIV	Selects calibrated deflection factors from 10 mV/Div to 1 V/Div; 7 steps in a 1-2-5 sequence.
POSITION	Controls the position of the trace.
IDENTIFY	Deflects the trace about 0.3 division for trace identification. In instruments with readout, also replaces readout with the word "IDENTIFY".
GAIN Adjustment	Screwdriver adjustment permits calibration of deflection factor.
POLARITY	Provides a means of inverting the display. +UP: A positive-going signal at the INPUT connector deflects the CRT display upward.

INVERT: A positive-going signal at the INPUT connector deflects the CRT display downward.

Input Coupling Switch

Selects signal input coupling mode.

AC: The AC component of the signal is coupled to the amplifier input while the DC component is blocked.

AC GND: Grounds the amplifier input while maintaining the same AC load for the input signal.

PRE-CHG: Provides a charge path for the AC coupling capacitor to pre-charge the input circuit before switching the Input coupling switch to AC.

DC: Both AC and DC components of the signal are coupled to the amplifier input.

DC GND: Grounds the amplifier input while maintaining the same DC load for the input signal.

INPUT Connector

Provides a means for connecting a signal.

VARIABLE DELAY (Option 4)

Delays the signal up to ± 500 picoseconds by using a calibrated 10 turn dial.

OPERATING INSTRUCTIONS and CHECKOUT

Probes

Probes recommended for use with the 7A19 are the P6056 (10X) or P6057 (100X). Both probes are compatible to 50 ohm systems, and will allow optimum frequency response. These probes also contain trace IDENTIFY and readout encoding functions.

Operating Instructions—7A19

If the P6201 Probe is used, a one megohm input impedance may be achieved. Consult your local TEKTRONIX Field Engineer or Representative for further information.

Vertical Gain Check and Adjustment

To check the gain of the 7A19, set the VOLTS/DIV switch to 10 mV and connect 20 mV, 1 kHz signal from the oscilloscope Calibrator to the INPUT connector. The vertical deflection should be exactly two divisions. If not, adjust the front panel GAIN control for exactly two vertical divisions.

Input Coupling

The input coupling switch allows a choice of input coupling methods. The type of display desired and the applied signal will determine the coupling to use.

The DC coupling position can be used for most applications. For AC signals with frequencies below about 1 kHz, and square waves whose low-frequency components are important to the display, it is necessary to use DC coupling to obtain a satisfactory presentation.

DC GND position disconnects the signal source from the amplifier and connects it to a resistive 50 ohm termination, thus providing the same type of load to the signal source. The input to the amplifier is also provided with a ground reference.

In the AC coupling position, the DC component of the signal is blocked by a capacitor in the input circuit. The AC coupling position provides the best display of signals with a DC component much larger than the AC component.

The PRE-CHG feature should be used when there is a possibility of having a residual charge on the input capacitor of the opposite polarity to the intended input, and when the algebraic sum of the charges may be greater than the maximum input limitations of the amplifier. To use this feature, first set the coupling switch to PRE-CHG, then connect the signal source to the INPUT and wait about two seconds for the coupling capacitor to charge, set the coupling switch to AC.

Another useful feature of the PRE-CHG position is that it can be used as a calibrated 100X attenuator having an input impedance of five kilohms in series with two microfarads. This extends the Low Frequency response to less than 20 Hz. Input power should be limited to 1/8 watt in this mode.

The AC GND position disconnects the signal source from the amplifier and connects it to a capacitive coupled 50 ohm termination, thus providing the same type of load to the signal source. The input to the amplifier is also provided with a ground reference.

VOLTS/DIV Switch

The amount of deflection produced by a signal is determined by the signal amplitude, the attenuation factor of the probe, the setting of the VOLTS/DIV switch, and the setting of the Input Coupling switch. Calibrated deflection factors represented by the VOLTS/DIV switch apply only when the probe attenuation is X1 and when the Input Coupling switch is not in the PRE-CHG position (the PRE-CHG position has an attenuation of 100X).

POLARITY Switch

The POLARITY switch provides a means of inverting the displayed signal. With the POLARITY switch set to +UP, a positive-going signal at the INPUT produces an upward deflection of the CRT display. With the POLARITY switch set to INVERT, a positive-going signal will produce a downward deflection of the CRT display.

Trace Identification and Readout Functions

When the IDENTIFY button is pressed, the trace is deflected upward about 0.3 division to identify the 7A19 trace. This feature is particularly useful when multiple traces are displayed on the CRT. In mainframes with readout, it also replaces the deflection factor readout with the word "IDENTIFY".

The 7A19 is equipped with probe encoding circuitry that, when used with a coded probe, corrects the deflection factor readout.

VARIABLE DELAY (Option 4)

The optional VARIABLE DELAY line provides a means for delaying the signal applied to the INPUT for up to ± 500 ps.

APPLICATIONS

General

The following information describes the procedures and techniques for making measurements with a 7A19 and the associated TEKTRONIX oscilloscope and time-base. These applications are not described in detail, since each application must be adapted to the requirements of the individual measurements. This instrument can also be used for many applications which are not described in this

manual. Contact your local TEKTRONIX Field Office or representative for assistance in making specific measurements.

Peak-to-Peak Voltage Measurements (AC)

To make peak-to-peak voltage measurements, use the following procedure:

1. Apply the signal to the INPUT connector.
2. Set the Coupling switch to AC.

NOTE

For low-frequency signals below about 1 kHz, use the DC position to prevent attenuation of the signal.

3. Set the VOLTS/DIV switch to display about five vertical divisions of the waveform.

4. Set the time-base Triggering controls for a stable display. Set the time base to a sweep rate which displays several cycles of the waveform.

5. Turn the 7A19 POSITION control so the lower portion of the waveform coincides with one of the graticule lines below the center horizontal line, and the top of the waveform is within the viewing area. With the time base Position control, move the display so one of the upper peaks lies near the center vertical line (see Fig. 2-1).

6. Measure the divisions of vertical deflection peak to peak.

NOTE

This technique can also be used to make measurements between two points on the waveform, rather than peak to peak.

7. Multiply the distance measured in step 6 by the VOLTS/DIV switch setting. Include the attenuation factor of the probe, if used.

EXAMPLE: Assume that the peak to peak vertical deflection is 4.5 divisions using a 10X attenuator probe, and the VOLTS/DIV switch is set to 1 V.

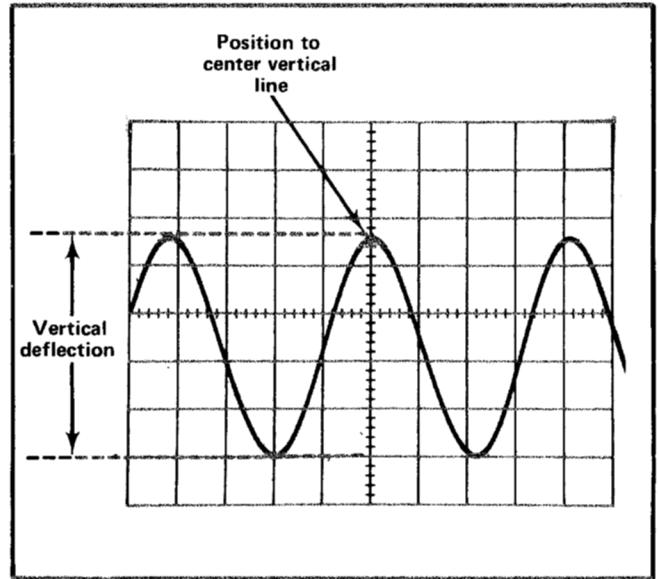

Fig. 2-1. Measuring the peak to peak voltage of a waveform.

$$\text{Volts} = \text{vertical deflection (divisions)} \times \text{VOLTS/DIV setting} \times \text{probe attenuator factor}$$

Substituting the given values:

$$\text{Volts Peak to Peak} = 4.5 \times 1 \times 10$$

The peak-to-peak voltage is 45 volts.

When using a coded probe and an oscilloscope equipped with readout, simply multiply the distance measured in step 6 by the deflection factor displayed on the CRT.

Instantaneous Voltage Measurements (DC)

To measure the DC level at a given point on a waveform, proceed as follows:

1. Connect the signal to the INPUT connector.
2. Set the VOLTS/DIV switch to display about five divisions.
3. Set the Coupling switch to GND, and position the trace to the bottom graticule line or other reference line. If the voltage is negative with respect to ground, position the

Operating Instructions--7A19

trace to the top graticule line. Do not move the POSITION control after this reference line has been established.

4. Set the Coupling switch to DC. The ground reference line can be checked at any time by switching to the GND position.

NOTE

To measure a voltage level with respect to another voltage rather than ground, make the following changes to Step 4. Set the Coupling switch to DC and apply the reference voltage to the INPUT connector. Then position the trace to the reference line and disconnect the reference voltage.

5. Set the time-base Triggering controls for a stable display. Set the Time Base sweep rate for an optimum display of the waveform.

6. Measure the distance in divisions between the reference line and the point on the waveform at which the DC level is to be measured. For example, in Fig. 2-2 the measurement is between the reference line and point A.

7. Establish the polarity of the waveform. With the POLARITY switch in the NORM position, any point above the reference line is positive.

8. Multiply the distance measured in step 6 by the VOLTS/DIV switch setting. Include the attenuation factor of the probe, if used.

EXAMPLE: Assume the vertical distance measured is 3.6 divisions (see Fig. 2-2) and the waveform is above the reference line, using a 10X probe with a VOLTS/DIV switch setting of 0.5 V.

Using the formula:

$$\text{Instantaneous voltage} = \text{vertical distance (divisions)} \times \text{polarity} \times \text{VOLTS/DIV setting} \times \text{probe attenuation factor}$$

Substituting the given values:

$$\text{Instantaneous Voltage} = 3.6 \times 1 \times 0.5 \text{ V} \times 10$$

The instantaneous voltage is 18 volts.

Matching transit times using two 7A19's, one having VARIABLE DELAY (Option 4)

In some applications it is necessary to view the time relationship of two signals, one with respect to the other.

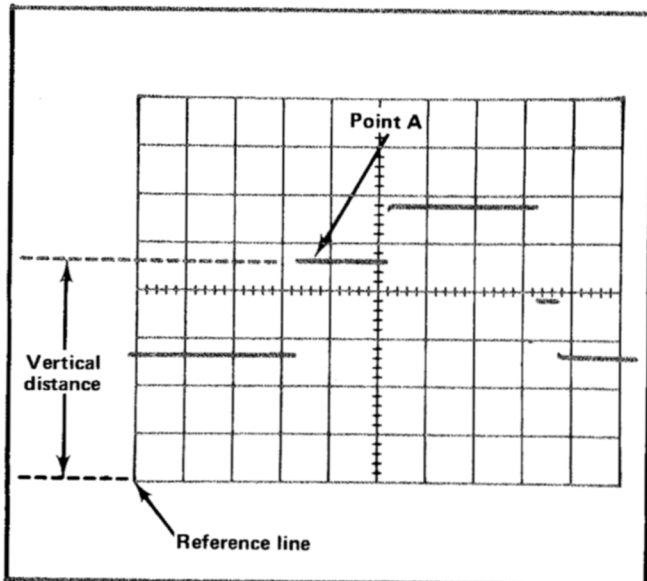

Fig. 2-2. Measuring instantaneous voltage with respect to same reference.

With high speed signals, the transit times of the probes and amplifiers can distort the true time relationship of the two signals. By using the VARIABLE DELAY (Option 4), the transit times between two units can be matched to within 50 ps, thus giving a true time relationship of the signals being viewed.

For matching transit times of two 7A19 with probes, proceed as follows:

1. Install the 7A19 without the VARIABLE DELAY option in the left vertical plug-in compartment.
2. Install the 7A19 with VARIABLE DELAY option in the right vertical plug-in compartment.
3. Connect the probes to a common signal source of greater than 100 kHz and adjust the time-base unit for the fastest sweep available.
4. Set the Trigger Source switch to left Vert, and Vertical Mode to Alternate.
5. Set both 7A19's to the same deflection factor settings.
6. Center both displays vertically.
7. Adjust VARIABLE DELAY so that the two displays are superimposed. The transit times of both units are now matched.

CIRCUIT DESCRIPTION

Introduction

This section of the manual contains a description of the circuitry used in the 7A19 amplifier. The description begins with a discussion of the instrument using the block diagram shown in the Diagrams section. Then, each circuit is described in detail using block diagrams to show the interconnections between stages in each major circuit and the relationship of the front panel controls to the individual stages.

A complete schematic of the circuits are given in the Diagrams section. Refer to this schematic throughout the following circuit description for electrical values and relationship.

BLOCK DIAGRAM

The following discussion is provided to aid in understanding the overall concept of the 7A19 before the individual circuits are discussed in detail. Only the basic interconnections between the blocks are shown on the block diagram (see Diagrams section). Each block represents a major circuit in the instrument.

Signals to be displayed on the CRT are applied to the INPUT connector. The signal passes through the Input Coupling Switch, where the appropriate coupling is selected, to the Attenuators. The VOLTS/DIV switch selects the correct amount of attenuation.

Transit time for the 7A19 is standardized by the Fixed Delay Line. An optional Variable Delay Line can be ordered that allows the transit time of the plug-in to be varied up to 1 ns.

Signals from the Delay Line are connected to the Signal Line. The Signal Line represents a $50\ \Omega$ line that is connected to Signal Amplifier, Trigger Amplifier, Limiter, and is terminated in the Signal Line Terminator. Input impedance is effectively adjusted, therefore, by the Input Current control.

Overvoltage protection is provided by the Limiter circuitry and the fuse located in the Input Coupler.

The Signal Amplifier and Trigger Amplifier circuits are identical. They provide positioning and gain switching for the 10 mV and 20 mV ranges. GAIN calibration and temperature compensation is provided by the Gain Current Amplifier.

The Signal Amplifier and Trigger Amplifier is connected to the Polarity circuit where the oscilloscope is provided with +UP or inverted signal and trigger outputs. Outputs are connected to the oscilloscope via the interface connectors.

DETAILED CIRCUIT DESCRIPTION

Input Coupling

Input signals connected to the INPUT connector can be AC-coupled, DC-coupled, or internally disconnected. S5 is a cam-type switch; a contact-closure chart showing the operation is given on the schematic in the Diagrams section. When the Input Coupling Switch is in the DC position, the input signal is coupled directly to the Attenuator. The DC GND position disconnects the input signal from the Attenuators and connects it to ground through two $100\ \Omega$ resistors in parallel. Paralleling the $100\ \Omega$ resistors reduces the inductance associated with the resistors so that the combination will remain $50\ \Omega$ for all frequencies within the limits of this plug-in. Connected in a similar manner and for the same reasons are the input fuses F6 and F7. In the AC position, the input signal passes through capacitor C5. The capacitor prevents the DC component of the signal from passing to the Attenuator. AC GND position disconnects the input signal from the Attenuators and connects it to ground through C5 and the two $100\ \Omega$ resistors. This represents the same load to the signal source. The PRE-CHG position limits the instantaneous current caused by connecting a large signal to the INPUT connector by inserting a resistor in series with C5. Since this resistor is $4.95\ \text{k}\Omega$ and the input to the Attenuator is $50\ \Omega$, the PRE-CHG position will act as a X100 attenuator.

Attenuator

The effective overall deflection factor of the 7A19 is determined by the setting of the VOLTS/DIV switch, S135 and the Step Attenuator, A10. Gain switching for the 10 mV and 20 mV positions occur in the Signal and Trigger Amplifiers. The signal in the 10 mV and 20 mV position is passed through the Step Attenuator, unattenuated. Precision microwave attenuators, located in the Step Attenuator, are switched in at all other VOLTS/DIV positions.

Delay Lines

Unless Variable Delay Option 4 is requested, all 7A19's are equipped with a Fixed Delay Line consisting of a precision length of $50\ \Omega$ cable. The Fixed Delay Line is inserted in series with the Signal Line so that the transit times of all 7A19 plug-in's can be closely regulated. The optional Variable Delay Line, when requested, replaces the Fixed Delay Line.

Circuit Description--7A19

Signal Line Terminator

The Signal Line Terminator consists of a current sensing operational amplifier connected to the Signal Line. This operational amplifier senses changes in currents at the Signal Line and compensates by adding or subtracting currents. The Input Current control sets the quiescent current at the Signal Line. This is the major controlling factor for input impedance. Changes of input current due to positioning or polarity switching are also compensated by this circuit. R121 and C121 compensate for the addition of this circuit to the Signal Line.

Limiter

CR124, CR125 provide overload protection. An overload condition at the signal INPUT connector will cause one or both diodes to forward bias. If this condition continues, the current flowing through the diodes will soon cause the fuses F6, F7 to burn out. Diodes CR124, CR125 are connected to the Signal Line through an impedance matching "T" network, L124, L125, and C123.

Signal Amplifier and Trigger Amplifier

The Signal Amplifier and Trigger Amplifier circuitry are identical. The description for the Signal Amplifier applies equally to the Trigger Amplifier.

The Signal Amplifier consists mainly of a TEKTRONIX-made hybrid integrated circuit (U40) and its related circuitry. A representation of U40 is shown in the schematic diagrams section. The Signal Line is connected to the Signal Amplifier input through a "T" network consisting of C20, L21, and L22. The "T" coils, L21 and L22 are adjusted for minimum aberrations at high frequencies. The paraphase input of U40 converts the single ended input to a differential signal. Frequency compensation, signal balancing, gain, and temperature compensation are all accomplished in the emitters of the paraphase amplifier. Frequency compensation is achieved through the use of the series of resistors, capacitors, and an inductor connected to pins 5 and 11. R38 signal balance control balances out the resultant currents in the amplifier.

Gain Current Source

Temp Comp control, R76, sets the voltage at the emitter of Q76. The current through R74 is set by the current generator Q73 and Gain control R73. As the thermal resistor R74 changes with temperature so will the voltage at the collector of Q73; therefore, compensating for temperature changes within the plug-in.

Positioning is achieved by varying the DC level at the input of the paraphase amplifier (pin 4, U40). Q56A and Q56B is a DC amplifier having an inverting input and non-inverting input. Gain of this amplifier is selected by the VOLTS/DIV switch. With the VOLTS/DIV switch in the 10 mV position, the gain of Q56 is set by R66. In the 20 mV position the gain of Q56 is doubled. The POSITION control (R68) applies a DC signal to either the inverting or non-inverting input. This is selected so that a clockwise rotation of the POSITION control will always produce an upward deflection of the displayed trace. The output of the position amplifier is applied to the Signal and Trigger Amplifier through an inverting buffer Q50. This signal is also applied to the Signal Line Terminator which compensates for the current changes that occur as a result of the positioning circuitry.

Polarity Circuit

The output from the Signal and Trigger Amplifiers is connected through the Polarity switch to the interface connector. The Polarity switch, in the INVERT position, not only inverts the Signal and Trigger outputs but it inverts the polarity signal so that a clockwise rotation of the POLARITY control always produces an upward deflection. See the description for the Position Circuit for details.

Connectors

All connections made to the mainframe by the 7A19 are shown on the schematic located in the Diagrams section of this manual. Also shown are the power supply decoupling components.

Readout

The 7A19 incorporates standard vertical readout encoding circuitry. Refer to any 7000-Series Oscilloscope with readout for more information.

MAINTENANCE

Introduction

This section of the manual contains maintenance information for use in preventive maintenance, corrective maintenance, and troubleshooting of the 7A19.

Further maintenance information relating to general maintenance can be found in the instruction manuals for the 7000-Series oscilloscopes.

PREVENTIVE MAINTENANCE

General

Preventive maintenance, consisting of cleaning, visual inspection, etc., performed on a regular basis, will improve the reliability of this instrument. Periodic checks of the semiconductor devices used in the unit are not recommended as a preventive maintenance measure. See semiconductor-checking information given under Troubleshooting.

Cleaning

Front Panel. Loose dust may be removed with a soft cloth or a dry brush. Water and mild detergent may be used; however, abrasive cleaners should not be used.

Interior. Cleaning the interior of the unit should precede calibration, since the cleaning process could alter the settings of the calibration adjustments. Use low-velocity compressed air to blow off the accumulated dust. Hardened dirt can be removed with a soft, dry brush, cotton-tipped swab, or cloth dampened with a mild detergent and water solution.

Lubrication

Use a cleaning-type lubricant on shaft bushings in connecting plug contacts, and switch contacts. Lubricate switch detents with a heavier grease. A lubrication kit containing the necessary lubricating materials and instructions is available through any TEKTRONIX Field Office. Order by TEKTRONIX Part No. 003-0342-01. Local purchase is recommended whenever possible.

TROUBLESHOOTING

General

The following is provided to augment information contained in other sections of this manual when troubleshooting the 7A19. The schematic diagrams, circuit descrip-

tion, and calibration sections should be used to full advantage. The circuit description section gives detailed information on circuit behavior and output requirements.

Troubleshooting Aids

Diagrams. Circuit diagrams are given on foldout pages in Section 7. The circuit number and electrical value of each component in this instrument are shown on the diagrams. Important voltages and semiconductor lead configurations are also shown.

Circuit Board. The circuit board used in the 7A19 is outlined on the schematic diagrams, and a photograph of the board is shown on the back of the schematic diagrams. Each board-mounted electrical component is identified on the photograph by its circuit number.

Component and Wiring Color Code. Colored stripes or dots on resistors and capacitors signify electrical values, tolerances, etc., according to the EIA standard color code. Components not color coded usually have the value printed on the body.

The insulated wires used for interconnection in the 7A19 are color coded to facilitate tracing a wire from one point to another in the unit.

Troubleshooting Equipment

The following equipment is useful for troubleshooting the 7A19.

1. Semiconductor Tester—Some means of testing the transistors and diodes, used in this instrument is helpful. A transistor-curve tracer such as the TEKTRONIX Type 576 will give the most complete information.

2. DC Voltmeter and Ohmmeter—A voltmeter for checking voltages within the circuit and an ohmmeter for checking resistors and diodes is required.

3. Test Oscilloscope—A test oscilloscope is required to view waveforms at different points in the circuit. A TEKTRONIX 7000-Series Oscilloscope equipped with a readout system, 7D13 Digital Multimeter unit, 7B-Series Time-Base unit, and a 7A-Series Amplifier unit with a 10X probe will meet the needs of both items 2 and 3.

4. Plug-in Extender—A fixture that permits operation of the unit outside of the plug-in compartment for better accessibility during troubleshooting. Order TEKTRONIX Part No. 067-0616-00.

Troubleshooting Procedure

This troubleshooting procedure is arranged in an order which checks the simple trouble possibilities before proceeding with extensive troubleshooting.

1. Check Control Settings. An incorrect setting of the 7A19 controls can indicate a trouble that does not exist. If there is any question about the correct function or operation of a control or front-panel connector, see Section 2.

2. Check Associated Equipment. Before proceeding with troubleshooting of the 7A19 check that the equipment used with this instrument is operating correctly. If possible, substitute an amplifier unit known to be operating correctly into the indicator unit and see if the problem persists. Check that the input signals are properly connected and that the interconnecting cables are not defective.

3. Visual Check. Visually check the portion of the instrument in which the trouble is suspected. Many troubles can be located by visual indications, such as unsoldered connections, broken wires, damaged circuit boards, damaged components, etc.

4. Check Instrument Performance. Check the calibration of the unit, or the affected circuit by performing Performance Checks of Section 5. The apparent trouble may only be a result of mis-adjustment and may be corrected by calibration.

5. Check Voltages. Often the defective component or stage can be located by checking for the correct voltage in the circuit. Typical voltages are given on the diagrams; however, these are not absolute and may vary slightly between instruments. To obtain operating conditions similar to those used to take these readings, see the instructions in the Diagrams section.

6. Check Individual Components. The following methods are provided for checking the individual components in the 7A19. Components which are soldered in place are best checked by disconnecting one end to isolate the measurement from the effects of surrounding circuitry.

A. TRANSISTORS AND INTEGRATED CIRCUITS. The best check of transistor operation is actual performance under operating conditions. If a semiconductor is suspected of being defective, it can best be checked by substituting a component known to be good; however, be sure that circuit conditions are not such that a replacement might also be damaged. If substitute transistors are not available, use a dynamic tester (such as TEKTRONIX Type 576). Static-type testers may be used, but since they do not check operation under simulated operating conditions, some defects may go unnoticed. The schematic shows base pin and socket arrangements of semiconductor devices. Be sure the power is off before attempting to remove or replace any semiconductor component.

Integrated circuits can be checked with a voltmeter, test oscilloscope, or by direct substitution. A good understanding of the circuit description is essential to troubleshooting circuits using integrated circuits. Use care when checking voltages and waveforms around the integrated circuits so that adjacent leads are not shorted together.

B. DIODES. A diode can be checked for an open or for a short circuit by measuring the resistance between terminals with an ohmmeter set to the R X 1k scale. The diode resistance should be very high in one direction and very low when the meter leads are reversed. Do not check tunnel diodes or back diodes with an ohmmeter.



Do not use an ohmmeter scale that has a high internal current. High currents may damage the diodes.

C. RESISTORS. Check resistors with an ohmmeter. Resistor tolerance is given in the Electrical Parts List. Resistors normally do not need to be replaced unless the measured value varies widely from the specified value.

D. CAPACITORS. A leaky or shorted capacitor can be detected by checking resistance with an ohmmeter on the highest scale. Use an ohmmeter which will not exceed the voltage rating of the capacitor. The resistance reading should be high after initial charge of the capacitor. An open capacitor can best be detected with a capacitance meter, or by checking whether the capacitor passes AC signals.

7. Repair and Readout the Circuit. Special techniques required to replace components in this unit are given under Component Replacement. Be sure to check the performance of any circuit that has been repaired or that has had any electrical components replaced. Recalibration of the affected circuit may be necessary.

CORRECTIVE MAINTENANCE

General

Corrective maintenance consists of component replacement and instrument repair. Special techniques required to replace components in this instrument are given here.

Obtaining Replacement Parts

Standard Parts. All electrical and mechanical part replacements for the 7A19 can be obtained through your local TEKTRONIX Field Office or representative. However, many of the electronic components can be obtained locally in less time than is required to order them from Tektronix, Inc. Before purchasing or ordering replacement parts, check the parts list for value, tolerance, rating and description.

NOTE

When selecting replacement parts, it is important to remember that the physical size and shape of a component may affect the performance of the instrument, particularly at high frequencies. All replacement parts should be direct replacements unless it is known that a different component will not adversely affect instrument performance.

Special Parts. In addition to the standard electronic components, some special parts are used in the 7A19. These parts are manufactured or selected by Tektronix, Inc., in accordance with our specifications. These special parts are indicated in the parts list by an asterisk preceding the part number. Most of the mechanical parts used in this instrument have been manufactured by Tektronix, Inc. Order all special parts directly from your local TEKTRONIX Field Office or representative.

Ordering Parts. When ordering replacement parts from Tektronix, Inc., include the following information:

1. Instrument Type.
2. Instrument Serial Number.
3. A description of the part (if electrical, include circuit number).
4. TEKTRONIX Part Number.

Soldering Techniques

WARNING

Disconnect the instrument from the power source before soldering.

Circuit Boards. The components mounted on the circuit boards in the 7A19 can be replaced using normal circuit board soldering techniques. Keep the following points in mind when soldering on the circuit board:

1. Use a pencil-type soldering iron with a wattage rating from 15 to 50 watts.
2. Apply heat from the soldering iron to the junction between the component and the circuit board.
3. Heat-shunt the lead to the component by means of a pair of long-nose pliers.
4. Avoid excessive heating of the junction with the circuit board, as this could separate the circuit board wiring from the base material.
5. Use electronic grade 60-40 tin lead solder.
6. Clip off any excess lead length extending beyond the circuit board. Clean off any residual flux with a flux-removing solvent.

Metal Terminals. When soldering metal terminals (potentiometers, etc.) use 60-40 tin lead solder and a 15 to 50 watt soldering iron. Observe the following precautions when soldering metal terminals:

1. Apply only enough heat to make the solder flow freely.
2. Apply only enough solder to form a solid connection. Excess solder may impair the function of the part.
3. If a wire extends beyond the solder joint, clip off the excess.
4. Clean the flux from the solder joint with a flux-removing solvent.

Component Replacement

WARNING

Disconnect the equipment from the power source before replacing components.

Semiconductor Replacement. Transistors and integrated circuits (IC's) should not be replaced unless actually defective if removed from their sockets during routine maintenance, return them to their original sockets. Unnecessary replacement of semiconductors may affect the calibration of this instrument. When semiconductors are replaced, check the performance of the part of the instrument which may be affected.

Replacement semiconductors should be of the original type or a direct replacement. Lead configuration of the semiconductors used in this instrument are shown on the schematic diagrams. If the replacement semiconductor is not of the original type, check the manufacturer's basing diagram for proper basing.

TEKTRONIX Integrated Circuits. If it should become necessary to replace the TEKTRONIX integrated circuits U40 and U100 use the following procedures:

1. Remove the common heat sink (No. 64 in Fig. 1 EXPLODED of the Mechanical Parts List section).
2. Unsolder the two ground straps from either side of the integrated circuit case and unplug the integrated circuit.
3. To install, align the tab of the integrated circuit with the dot, marked on the circuit board. Then, making sure pins are aligned with their sockets, gently push into the socket.

NOTE

The leads of the integrated circuit are cut at the factory to prevent the integrated circuit from resting directly on the circuit board. Defeating this purpose may allow the pin sockets to short against the integrated circuit case. Solder the ground leads to the case and replace the heat sink.

Inductor Replacement (L21, L22, L81, L82, L124, L125). Inductors are replaced as a pair along with their associated capacitor (e.g., L21, L22, and C20). The inductors are formed by the leads of the capacitor, see Fig. 4-1. To replace a pair of inductors, proceed as follows:

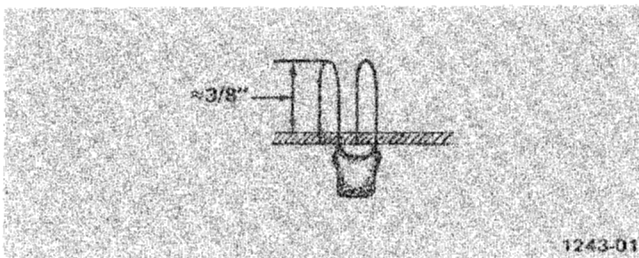

Fig. 4-1. Inductor ("T" coil) replacement.

1. Remove the inductors and associated capacitor by using a low wattage soldering iron and a vacuum type desoldering device.

2. Insert the replacement capacitor on the circuit board and bend the leads to form a loop approximately 3/8 inch high.

3. Solder the capacitor and inductors to the circuit board.

Replacement of any of the inductors will affect the high frequency characteristics of the 7A19 and re-calibration will be necessary.

REPACKAGING FOR SHIPMENT

If the Tektronix instrument is to be shipped to a Tektronix Service Center for service or repair, attach a tag showing: owner (with address) and the name of an individual at your firm that can be contacted, complete instrument serial number and a description of the service required.

Save and re-use the package in which your instrument was shipped. If the original packaging is unfit for use or not available, repackage the instrument as follows:

1. Obtain a carton of corrugated cardboard having inside dimensions of no less than six inches more than the instrument dimensions; this will allow for cushioning. Refer to the following table for carton test strength requirements.
2. Surround the instrument with polyethylene sheeting to protect the finish of the instrument.
3. Cushion the instrument on all sides by tightly packing dunnage or urethane foam between carton and instrument, allowing three inches on all sides.
4. Seal carton with shipping tape or industrial stapler.

SHIPPING CARTON TEST STRENGTH

Gross Weight (lb)	Carton Test Strength (lb)
0-10	200
10-30	275
30-120	375
120-140	500
140-160	600

CALIBRATION

Introduction

To assure instrument accuracy, check the calibration of the 7A19 every 1000 hours of operation or every six months if used infrequently. Before complete calibration, thoroughly clean and inspect this instrument as outlined in the Maintenance section.

TEKTRONIX Field Service

Tektronix, Inc., provides complete instrument repair and recalibration service at local Field Service Centers and the Factory Service Center. Contact your local field office or representative for further information.

Performance Check

The performance of this instrument can be checked by performing only the ✓ CHECK steps. Performing the steps marked with a ✓ indicates that the instrument is checked against the tolerances listed as a Performance Requirement (see Specification section).

Limits and tolerances given in other check steps are calibration guides and should not be interpreted as instrument specifications. Operator front-panel adjustments are adjusted as part of the Performance Check procedure.

Calibration

To verify proper calibration of the 7A19 and to prevent unnecessary re-calibration of the entire instrument, perform the Adjust- portion of a step only if the tolerance given in the Check- part of the step is not met.

For best overall instrument performance when performing a complete calibration procedure, make each adjustment to the exact setting even if the Check- is within allowable tolerance.

TEST EQUIPMENT REQUIRED

General

The following test equipment and accessories, or its equivalent, is required for complete calibration of the 7A19. Specifications given for the test equipment are the minimum necessary for accurate calibration. Therefore, the specifications of any test equipment used must meet or exceed the listed specifications. All test equipment is assumed to be correctly calibrated and operating within the listed specifications. Detailed operating instructions for the test equipment are not given in this procedure. Refer to the instruction manual for the test equipment if more information is needed.

Special Calibration Fixtures

Special TEKTRONIX calibration fixtures are used in this procedure only where they facilitate instrument calibration. These special calibration fixtures are available from Tektronix, Inc. Order by part number through your local TEKTRONIX Field Office or representative.

Calibration Equipment Alternatives

All of the listed test equipment is required to completely check and adjust this instrument. The Calibration procedure is based on the first item of equipment given as an example of applicable equipment. When other equipment is substituted, control settings or calibration setup may need to be altered slightly to meet the requirements of the substitute equipment. If the exact item of test equipment given as an example in the Test Equipment list is not available, first check the Specifications column carefully to see if any other equipment is available which might suffice. Then check the Usage column to see what this item of test equipment is used for. If used for a check or adjustment which is of little or no importance to your measurement requirements, the item and corresponding step(s) can be deleted.

Test Equipment

Description	Minimum Specifications	Usage	Examples of Applicable Test Equipment
1. Calibration Oscilloscope	TEKTRONIX 7000-Series 500 MHz bandwidth required for complete procedure.	Used throughout the procedures to provide display.	a. TEKTRONIX 7904 oscilloscope.
2. Time Base Plug-In Unit	TEKTRONIX 7B-Series time base unit. 0.5 ns sweep rate required for complete procedure.	Used throughout procedure to provide sweep.	a. TEKTRONIX 7B92A Time Base unit.
3. Vertical Plug-In Unit	TEKTRONIX 7A-Series vertical plug-in unit. Dual trace with 500 μ V per division sensitivity required.	Used for Common Mode Check/Adjust (step 3) and Input Resistance Adjust.	a. TEKTRONIX 7A22 Dual Trace Vertical Amplifier.
4. Standard Amplitude Calibrator	Amplitude accuracy within 0.25%; range, 60 mV to 2 V into 50 Ω ; frequency, 1 kHz.	Used for GAIN Check/Adjust only (step 6).	a. Tektronix PG 506 Calibration Generator. ¹
5. Constant Amplitude Signal Generator	Reference frequency, less than 10 MHz; amplitude accuracy, within 1% of reference frequency; frequency range, to 500 MHz; amplitude range, 80 mV to 8 V into 50 Ω .	Used for Frequency Response Check (step 9).	a. SG 504 Leveled Sine Wave Generator. ¹ b. Wavetek 1002 Sweep/Signal Generator. c. General Radio 1362 UHF oscillator with 1263-C Amplitude Regulating supply.
6. Time Domain Reflectometer	System rise time, 350 ps \pm 35 ps; pulse amplitude, 200 mV. Sensitivity, to 100 μ p.	Used for Reflection Coefficient Check only (step 10).	a. TEKTRONIX 7S12 TDR/SAMPLER plug-in unit with S-1 sampling head and S-52 Pulse Generator head. (This system is to be used with the Calibration Oscilloscope.)
7. Differential Sampling System	System rise time, at least 350 ps; pulse amplitude, 200 mV; Input, differential; sensitivity, 50 mV/div.	Used for Rise Time and Aberration Check/Adjust only (step 8).	a. Use the Time Domain Reflectometer system with the addition of a 7S11 vertical sampling plug-in and a S-1 sampling head.
ACCESSORIES 8. Cable	Impedance, 50 ohms; length, 42 inches; connectors, BNC.	Used throughout procedures for signal connections.	a. TEKTRONIX Part No. 012-0057-01.
9. GR Cable	Impedance, 50 ohms \pm 5%; length, 10 inches; connectors, GR.	Used for signal connections during reflection coefficient and HF aberrations.	a. TEKTRONIX Part No. 017-0513-00.

¹ Requires TM 500 - Series Power Module

Test Equipment (cont)

Description	Minimum Specifications	Usage	Examples of Applicable Test Equipment
10. GR Cable	Impedance, 50 ohms $\pm 5\%$; length, 20 inches; connectors, GR.	Used during reflection coefficient check for signal connection.	a. TEKTRONIX Part No. 017-0515-00.
11. Adapter	BNC male to GR.	Used throughout procedures.	a. TEKTRONIX Part No. 017-0064-00.
12. Adapter	BNC female to GR.	Used throughout procedures.	a. TEKTRONIX Part No. 017-0063-00.
13. Adapter	BNC "T".	Used for common mode check/adjust.	a. TEKTRONIX Part No. 103-0030-00.
14. Adapter	BNC female to BNC female.	Used for common mode check/adjust.	a. TEKTRONIX Part No. 103-0028-00.
15. Adapter	SMA (3-mm) male to GR.	Used for reflection coefficient and risetime and aberrations.	a. TEKTRONIX Part No. 015-1007-00.
16. 50 Ω Power Divider	Impedance, 50 ohms; connectors, GR.	Used for reflection coefficient check.	a. TEKTRONIX Part No. 017-0082-00.
17. 10X Attenuator	Impedance, 50 ohms; accuracy, $\pm 2\%$; connectors, GR.	Used for frequency response check.	a. TEKTRONIX Part No. 017-0078-00.
18. Plug-in Extender	Rigid plug-in extender for 7000-Series plug-ins.	Used throughout procedures.	a. TEKTRONIX Part No. 067-0589-00.
19. Plug-in Extender	Flexible plug-in extender for 7000-Series plug-ins.	Used for risetime and aberrations check/adjust.	a. TEKTRONIX Part No. 067-0616-00.
20. Signal Pick-off with GR adapters	Signal pick-off connects to the rear connector of 7000-Series vertical amplifiers for gaining access to signal and trigger lines.	Used for common mode check/adjust, HF aberration check and adjust.	a. TEKTRONIX Part No. 067-0655-00.

CALIBRATION PROCEDURE

General

The following procedure is arranged so that the 7A19 can be calibrated with the least interaction of adjustments and re-connection of equipment. The control settings and test equipment setup throughout this procedure continue from the preceding step(s) unless otherwise noted. Refer to Fig. 5-1 for location of adjustments.

NOTE

Control titles which are printed on the front panel of the 7A19 are capitalized in this procedure (e.g.,

POSITION). Internal adjustments and associated equipment controls are initially capitalized only (e.g., oscilloscope Vertical Mode).

Preliminary Procedure for Calibration

1. Remove the side panels of the plug-in.
2. Insert 7A19 with plug-in extender in the calibration oscilloscope left vertical compartment.
3. Insert the time-base unit in the calibration oscilloscope B Horizontal compartment.

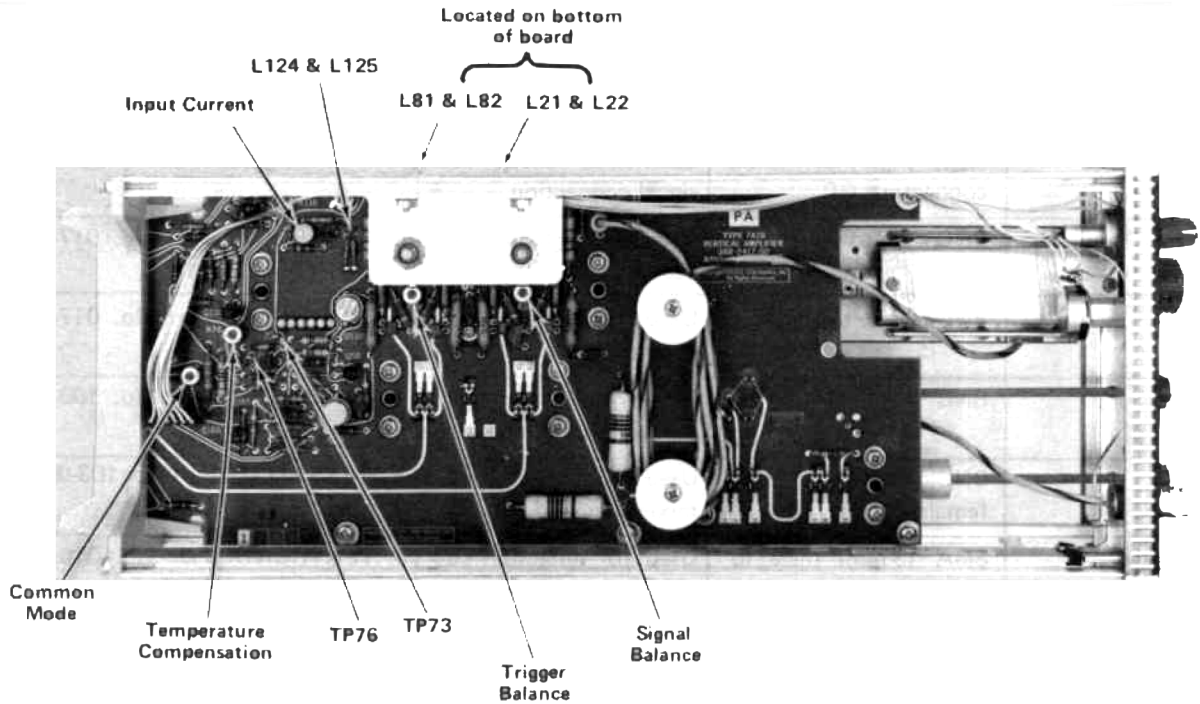

Fig. 5-1. Location of Adjustments (7A19 shown).

4. Connect the oscilloscope to a suitable power source.
5. Turn the oscilloscope on and allow 20 minutes warmup before proceeding.

	7A19
POSITION	Center trace
POLARITY	+UP
VOLTS/DIV	10 mV
Input Coupling	GND

NOTE

This instrument should be calibrated at an ambient temperature of +20°C to +30°C for best overall accuracy. The performance of the instrument can be checked at any temperature within the 0°C to +50°C range.

Preliminary Control Settings

Set the calibration oscilloscope and 7A19 as follows:

Calibration Oscilloscope

Intensity	Midrange
Focus	Adjust for a well-defined display
Control Illum	As desired
Grat Illum	As desired
Vertical Mode	Left
Trigger Source	Left Vert

Index to Calibration Procedure

1. Trigger Balance Check/Adjust
2. Balance Check/Adjust
3. Common Mode Check/Adjust
4. Input Current Adjust
5. Temperature Compensation Adjust
- √6. GAIN Check/Adjust
- √7. Input Resistance Adjust, Input Current Check
8. Aberration Check/Adjust
- √9. Frequency Response Check
- √10. Reflection Coefficient Check

1. Trigger Balance Check/Adjust

a. Interchange the + signal line (A-11) with the + trigger line (A-13) in the plug-in extender.

b. Interchange the – signal line (B-11) with the – trigger line (B-13) in the plug-in extender.

c. Check—for less than 0.5 division vertical trace shift while switching the POLARITY switch between +UP and INVERT.

d. Adjust—the Trigger Bal control for minimum vertical trace shift as the POLARITY switch is alternated between +UP and INVERT.

e. Reconnect the signal and trigger lines to their proper connectors in the plug-in extender.

2. Balance Check/Adjust

a. Check—for less than 0.5 division vertical trace shift while switching the POLARITY switch between +UP and INVERT.

b. Adjust—the Bal control for minimum vertical trace shift as the POLARITY switch is alternated between +UP and INVERT.

c. Set the POLARITY switch to +UP.

3. Common Mode Check/Adjust

a. Disconnect the signal lines from the plug-in extender (A11 and B11 BNC cables) and short the signal lines together using a BNC “T” adapter. Connect the “T” adapter to the Vertical plug-in unit via the BNC female to BNC female adapter and the 42 inch BNC cable.

b. Set the calibration oscilloscope Vertical Mode to Right. Set the vertical plug-in unit to obtain 50 mV/division DC sensitivity.

c. Check—that the oscilloscope display is 0 volts ± 50 mV.

d. Adjust—the Common Mode Bal control for 0 volts ± 50 mV.

e. Disconnect all test equipment and reconnect the signal lines to the plug-in extender. Return the calibration oscilloscope Vertical Mode to Left.

4. Input Current Adjust

a. Adjust—the Input Current control for minimum vertical trace shift (± 1 division) while switching the Input Coupling switch between DC and GND.

b. Return the Input Coupling switch to DC.

5. Temperature Compensation Adjust

a. Connect a 1 kHz, 0.2 volt square-wave signal from the oscilloscope Calibrator to the 7A19 INPUT using a 42 inch BNC cable.

b. Set the 7A19 VOLTS/DIV switch to 50 mV.

c. Connect a shorting strap across the silicon resistor, R74 (TP73 and TP76 are connected to either side of R74 to provide a convenient means for connecting the shorting strap).

d. Adjust—the Temperature Compensation control by turning clockwise until the waveform just begins to increase.

e. Remove the shorting strap and return the VOLTS/DIV switch to 10 mV.

f. Disconnect all test equipment.

✓6. GAIN Check/Adjust

a. Connect the Standard Amplitude Calibrator output to the INPUT connector with a 42 inch BNC cable.

b. Set the Standard Amplitude Calibrator for a 60-millivolt square-wave output and set the Input Coupling switch to DC.

c. Check—CRT display for a vertical deflection of six divisions ± 0.18 division.

d. Adjust—Front panel GAIN control for exactly six divisions vertical deflection.

Calibration--7A19

CHECK DEFLECTION FACTOR ACCURACY

e. Check--Using the VOLTS/DIV switch and Standard Amplitude Calibrator settings given in Table 5-1, check that vertical deflection is within 3% for each position of the VOLTS/DIV switch.

f. Disconnect all test equipment and return the VOLTS/DIV switch to 10 mV.

TABLE 5-1

Vertical Deflection Accuracy

VOLTS/DIV Switch Setting	Standard Amplitude Calibrator Output	Vertical Deflection In Divisions	Maximum Error for ±3% Accuracy (Divisions)
10 mV	50 mV	5	Set in step 6
20 mV	0.10 V	5	±0.15
50 mV	0.5 V	5	±0.15
.1 V	0.5 V	5	±0.15
.2 V	1.0 V	5	±0.15
.5 V	2.5 V	5	±0.15
1 V	5 V	5	±0.15

√7. Input Resistance Adjust, Input Current Check

a. Set 7A19 VOLTS/DIV switch to 10 mV.

b. Connect test circuit as shown in Fig. 5-2.

c. Set calibration oscilloscope Vertical Mode to Right. Set the vertical plug-in unit to AC and obtain a sensitivity of 500 μV/div.

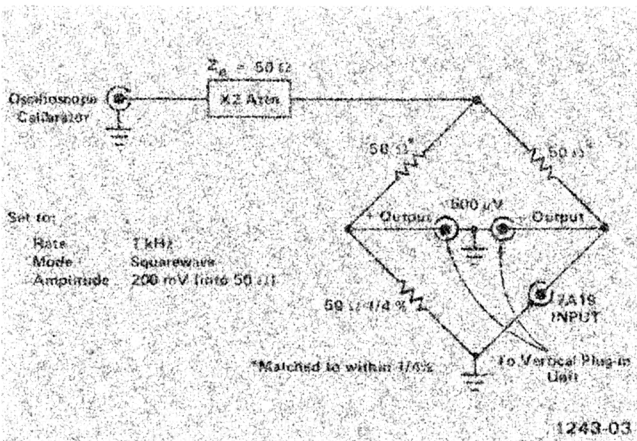

Fig. 5-2. Test circuit for adjusting input Resistance.

d. Adjust--Input Current control for a signal amplitude of one (1) division or less.

e. Disconnect the test circuit and set the calibration oscilloscope Vertical Mode to Left.

f. Check--for a vertical trace shift of 1 division or less while switching the Input Coupling switch between DC and GND. If not within 1 division, repeat steps 7b and 7c.

g. Return Input Coupling switch to DC.

8. Aberration Check/Adjust

a. Remove Rigid plug-in extender, Vertical plug-in unit, and Time Base unit from the Calibration Oscilloscope.

b. Install the 7S11 with the S1 head into the Left Vertical compartment. Install the 7S12 with the S1 and S52 heads into the Right Vertical and A Horizontal compartments.

c. Connect the Signal Pickoff fixture to the 7A19. Connect the Flexible Extender to the Signal Pickoff, and plug the Flexible Extender into the remaining oscilloscope horizontal compartment (to provide power to the 7A19).

d. Connect the Signal Pickoff + and - vertical lines (A11 to S1 head in 7S12, and B11 to S1 head in 7S11) to the Sampling system inputs using GR to TEKTRONIX adapters. Be sure the + and - trigger lines (A13 and B13) are connected to the Signal Pickoff internal 50 Ω termination.

e. Set the 7A19 VOLTS/DIV switch to 50 mV, and check POLARITY switch for + UP position.

f. Connect the sampling pulse generator output to the 7A19 INPUT by using a SMA to GR adapter, a 20 inch GR cable, and a GR to male BNC adapter.

g. Set the test oscilloscope (7904) to RIGHT and A HORIZ. Set the 7S12 controls as follows:

Variable (cal in)	50 mV
DC Offset	midrange
Locate/Scan	out
Rep	pushbutton in
Time/Div	X .1 5 ns
High Resolution	pushbutton out

h. Rotate the TIME - DISTANCE knob until brightened portion of the waveform appears over the leading edge of waveform. (The intensity may have to be re-adjusted to discern the brightened waveform).

i. Change the 7904 VERTICAL MODE switch to LEFT.

j. Push in the LOCATE pushbutton on the 7S12.

k. Push in the INVERT pushbutton on the 7S11, and set VARIABLE (CAL IN) to the 50 mV position. Set the DOT RESPONSE to NORMAL.

l. Position the waveform to mid-screen with the DC OFFSET control.

m. Set the 7904 VERTICAL MODE switch to CHOP.

n. Using the 7S11 and 7S12 DC OFFSET controls, position both waveforms so they overlap.

o. Use the 7S11 DELAY control and position the leading edge of the waveform so they coincide.

p. Change the 7904 VERTICAL MODE switch to ADD.

q. Check—that the aberrations are 7% peak to peak or less.

r. Adjust—inductors L21, L22, L81, L82, L124, and L125 for minimum aberrations. These coils are located on both sides of the circuit board, refer to Fig. 5-1 for their locations. Each coil affects a different portion of the step waveform, usually 2 to 10 ns after the initial step. To adjust the aberrations, use the following procedure:

1. Locate the portion of the step waveform that contains the largest aberration.

2. Locate the coil that affects that portion of the step waveform by bringing a metal screwdriver or similar metallic object close to each of the six coils.

3. After determining which coil affects the aberration, shorten or lengthen the coil to reduce the aberration (see illustration Fig. 5-3). Shortening the coil, by squeezing will cause a positive going aberration to decrease while lengthening the coil, by spreading, will cause a negative going aberration to decrease. See Fig. 5-4.

4. Continue with this procedure by choosing the next largest aberration and so on until the total aberration are 7% peak to peak or less.

s. Disconnect and remove all test equipment including sampling system.

NOTE

Slight misadjustment of the 7S11 Delay control will degrade the leading edge of the waveform. Re-adjust the Delay control to obtain optimum square corner, with minimum rolloff.

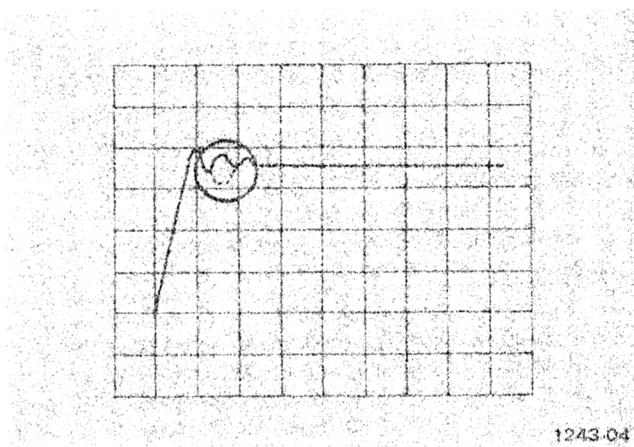

Fig. 5-3. Dotted line shows effects of bringing a metal screwdriver close to a "T" coil.

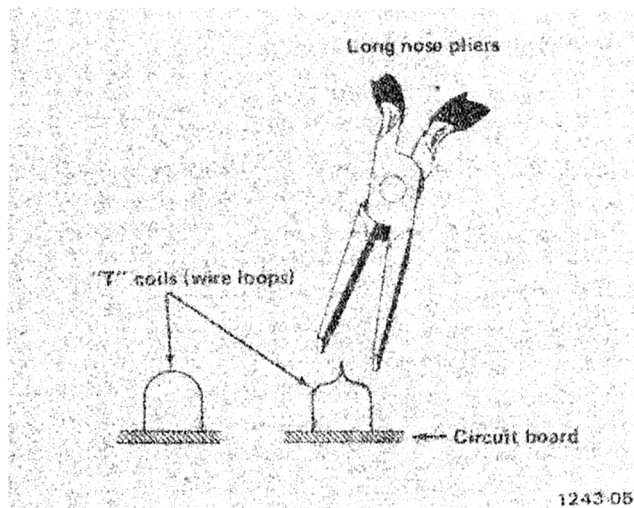

Fig. 5-4. Illustration showing method of squeezing "T" coils.

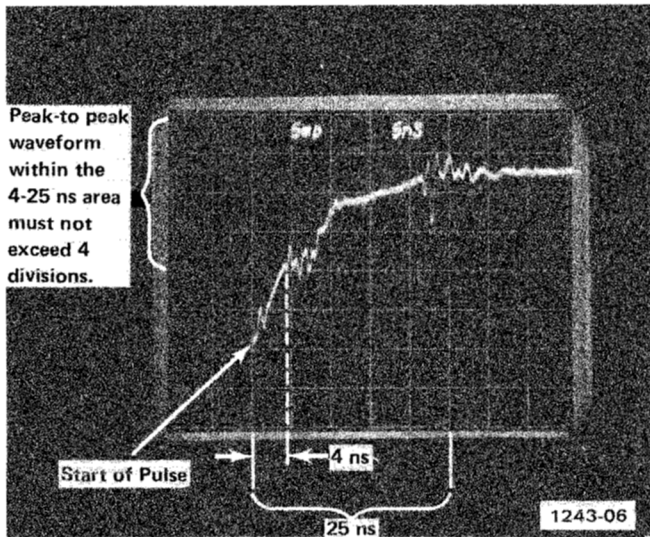

Fig. 5-5. Waveform showing a 4 division display corresponding to a reflection coefficient of 0.1 or less.

√9. Frequency Response Check

a. Remove the plug-in extender and install the 7A19 directly into the Left Vertical compartment. Install the Time Base plug-in unit into the Oscilloscope B Horizontal compartment. Set the calibration oscilloscope Vertical Mode to Left and Horizontal Mode to B.

b. Connect the Constant Amplitude sine-wave generator to the 7A19 using a 10X attenuator and a GR to BNC adapter.

c. Set the constant amplitude generator to its reference frequency and adjust the amplitude for a CRT display of exactly 8 divisions.

d. Increase the generator frequency to 500 MHz and check that the amplitude of the displayed signal is >5.6 divisions peak to peak.

e. Continue checking bandwidth for the entire VOLTS/DIV range using the constant amplitude generator settings and results given in Table 5-2.

TABLE 5-2

VOLTS/DIV Switch Setting	Constant Amplitude Generator (Set at Reference Frequency)	Amplitude Displayed with Generator Set to 500 MHz
10 mV	8 div	5.6 div
20 mV	8 div	5.6 div
50 mV	8 div	5.6 div
0.1 V	8 div	5.6 div
0.2 V	8 div	5.6 div
0.5 V	8 div	5.6 div
1 V	4 div	2.8 div

f. Return VOLTS/DIV to 20 mV.

√10. Reflection Coefficient Check

a. Install the 7S12 with the S1 and S52 heads into the Right Vertical and A Horizontal compartments.

b. Install the 7A19 into the Left Vertical compartment.

c. Connect the 50 Ω Power Divider Tee to the S1 head using a 20 inch GR cable and GR to BNC male adapter.

d. Connect the 50 Ω Power Divider Tee to the Pulse Output of the S52 head using a 10 inch GR cable and GR to 3 mm adapter.

e. Connect the 50 Ω Power Divider Tee to the 7A19 using a 2 ns cable.

f. Set the 7A19 VOLTS/DIV control to 10 mV/div, POLARITY to + UP, and INPUT to DC.

g. Set the test oscilloscope (7904) to RIGHT and A HORIZ. Set the 7S12 controls as follows:

Variable (cal in)	50 mV
DC Offset	midrange
Locate/Scan	out
Rep	pushbutton in
Time/Div	X .1 5 ns
High Resolution	pushbutton out
mρ	pushbutton in

h. Position the waveform to midscreen using the DC OFFSET control.

i. Set the intensified zone to fall on the rise portion of the pulse, using the TIME/DISTANCE control.

j. Push LOCATE button.

k. Adjust—Front panel P CAL control for a 4 division peak to peak display.

l. Change the VARIABLE (CAL IN) control to 5.

m. Position the top portion of the waveform to midscreen, using the DC OFFSET control (see Fig. 5-5).

n. Set SCAN control for no rolloff of front corner of the waveform.

o. Check—the peak to peak waveform for a 4 division display or less, as observed within the 4–25 nsec area (see Fig. 5-5). This corresponds to a reflection coefficient of 0.1 or less. If more than four divisions, repeat steps 7, 8, and 9.

This completes the calibration/check of the 7A19.

REPLACEABLE ELECTRICAL PARTS

PARTS ORDERING INFORMATION

Replacement parts are available from or through your local Tektronix, Inc. Field Office or representative.

Changes to Tektronix instruments are sometimes made to accommodate improved components as they become available, and to give you the benefit of the latest circuit improvements developed in our engineering department. It is therefore important, when ordering parts, to include the following information in your order: Part number, instrument type or number, serial number, and modification number if applicable.

If a part you have ordered has been replaced with a new or improved part, your local Tektronix, Inc. Field Office or representative will contact you concerning any change in part number.

Change information, if any, is located at the rear of this manual.

SPECIAL NOTES AND SYMBOLS

X000 Part first added at this serial number

00X Part removed after this serial number

ITEM NAME

In the Parts List, an Item Name is separated from the description by a colon (:). Because of space limitations, an Item Name may sometimes appear as incomplete. For further Item Name identification, the U.S. Federal Cataloging Handbook H6-1 can be utilized where possible.

ABBREVIATIONS

ACTR	ACTUATOR	PLSTC	PLASTIC
ASSY	ASSEMBLY	QTZ	QUARTZ
CAP	CAPACITOR	RECP	RECEPTACLE
CER	CERAMIC	RES	RESISTOR
CKT	CIRCUIT	RF	RADIO FREQUENCY
COMP	COMPOSITION	SEL	SELECTED
CONN	CONNECTOR	SEMICOND	SEMICONDUCTOR
ELCTLT	ELECTROLYTIC	SENS	SENSITIVE
ELEC	ELECTRICAL	VAR	VARIABLE
INCAND	INCANDESCENT	WW	WIREWOUND
LED	LIGHT EMITTING DIODE	XFMR	TRANSFORMER
NONWIR	NON WIREWOUND	XTAL	CRYSTAL

CROSS INDEX—MFR. CODE NUMBER TO MANUFACTURER

Mfr. Code	Manufacturer	Address	City, State, Zip
01121	ALLEN-BRADLEY COMPANY	1201 2ND STREET SOUTH	MILWAUKEE, WI 53204
03508	GENERAL ELECTRIC COMPANY, SEMI-CONDUCTOR PRODUCTS DEPARTMENT	ELECTRONICS PARK	SYRACUSE, NY 13201
03888	KDI PYROFILM CORPORATION	60 S JEFFERSON ROAD	WHIPPANY, NJ 07981
12697	CLAROSTAT MFG. CO., INC.	LOWER WASHINGTON STREET	DOVER, NH 03820
15454	RODAN INDUSTRIES, INC.	2905 BLUE STAR ST.	ANAHEIM, CA 92806
24931	SPECIALTY CONNECTOR CO., INC.	3560 MADISON AVE.	INDIANAPOLIS, IN 46227
72982	ERIE TECHNOLOGICAL PRODUCTS, INC.	644 W. 12TH ST.	ERIE, PA 16512
73138	BECKMAN INSTRUMENTS, INC., HELIPOT DIV.	2500 HARBOR BLVD.	FULLERTON, CA 92634
75042	TRW ELECTRONIC COMPONENTS, IRC FIXED RESISTORS, PHILADELPHIA DIVISION	401 N. BROAD ST.	PHILADELPHIA, PA 19108
75915	LITTELFUSE, INC.	800 E. NORTHWEST HWY	DES PLAINES, IL 60016
80009	TEKTRONIX, INC.	P O BOX 500	BEAVERTON, OR 97077
91637	DALE ELECTRONICS, INC.	P. O. BOX 609	COLUMBUS, NE 68601

Ckt No.	Tektronix Part No.	Serial/Model No. Eff	Dscont	Name & Description	Mfr Code	Mfr Part Number
A1	670-1889-00	B010100	B029999	CKT BOARD ASSY:VERTICAL AMPLIFIER * STANDARD ONLY	80009	670-1889-00
A1	670-1889-01	B030000	B037849	CKT BOARD ASSY:VERTICAL AMPLIFIER * STANDARD ONLY	80009	670-1889-01
A1	670-1889-02	B037850		CKT BOARD ASSY:VERTICAL AMPLIFIER * STANDARD ONLY	80009	670-1889-02
A1	670-1889-00	B010100	B039999	CKT BOARD ASSY:VERTICAL AMPLIFIER * OPTION 4 ONLY	80009	670-1889-00
A1	670-1889-01	B040000	B043049	CKT BOARD ASSY:VERTICAL AMPLIFIER * OPTION 4 ONLY	80009	670-1889-01
A1	670-1889-02	B043050		CKT BOARD ASSY:VERTICAL AMPLIFIER * OPTION 4 ONLY	80009	670-1889-02
A2	-----	XB030000		CKT BOARD ASSY:ATTENUATOR (A2, REPLACEABLE UNDER 672-0430-00 ONLY)		
C5	283-0278-00			CAP., FXD, CER DI: 2.2UF, 20%, 100V	72982	8150-M100Z5U225M
C20	283-0181-00	B010100	B037849	CAP., FXD, CER DI: 1.8PF, 10%, 100V * FURNISHED AS A UNIT WITH L21 AND L22 * STANDARD ONLY	72982	8101B121C0K0189B
C20	283-0158-00	B037850		CAP., FXD, CER DI: 1PF, (NOM VALUE), SEL * FURNISHED AS A UNIT WITH L21 AND L22	72982	8101B057C0K0109B
C20	283-0181-00	B010100	B043049	* STANDARD ONLY CAP., FXD, CER DI: 1.8PF, 10%, 100V * FURNISHED AS A UNIT WITH L21 AND L22 * OPTION 4 ONLY	72982	8101B121C0K0189B
C20	283-0158-00	B043050		CAP., FXD, CER DI: 1PF, (NOM VALUE), SEL * FURNISHED AS A UNIT WITH L21 AND L22	72982	8101B057C0K0109B
C24	283-0069-00	B010100	B011449	* OPTION 4 ONLY CAP., FXD, CER DI: 15PF, 20%, 50V * STANDARD ONLY	72982	811-059C0G0150M
C24	283-0069-00	B011450		CAP., FXD, CER DI: 15PF, (NOM VALUE), SEL * STANDARD ONLY	72982	811-059C0G0150M
C24	283-0069-00	B010100	B019999	CAP., FXD, CER DI: 15PF, 20%, 50V * OPTION 4 ONLY	72982	811-059C0G0150M
C24	283-0069-00	B020000		CAP., FXD, CER DI: 15PF, (NOM VALUE), SEL * OPTION 4 ONLY	72982	811-059C0G0150M
C26	283-0201-00			CAP., FXD, CER DI: 27PF, 10%, 200V	72982	8101B210X7R0270K
C28	283-0156-00			CAP., FXD, CER DI: 1000PF, +100-0%, 200V	72982	8111A208Z5U0102Z
C31	283-0182-00			CAP., FXD, CER DI: 51PF, 5%, 400V	72982	8110N400C0G510J
C35	283-0182-00			CAP., FXD, CER DI: 51PF, 5%, 400V	72982	8110N400C0G510J
C41	283-0182-00			CAP., FXD, CER DI: 51PF, 5%, 400V	72982	8110N400C0G510J
C47	283-0000-00			CAP., FXD, CER DI: 0.001UF, +100-0%, 500V	72982	831-516E102P
C58	283-0000-00			CAP., FXD, CER DI: 0.001UF, +100-0%, 500V	72982	831-516E102P
C61	283-0000-00			CAP., FXD, CER DI: 0.001UF, +100-0%, 500V	72982	831-516E102P
C73	283-0000-00			CAP., FXD, CER DI: 0.001UF, +100-0%, 500V	72982	831-516E102P
C80	283-0181-00	B010100	B037849	CAP., FXD, CER DI: 1.8PF, 10%, 100V * FURNISHED AS A UNIT WITH L81 AND L82. * STANDARD ONLY	72982	8101B121C0K0189B
C80	283-0158-00	B037850		CAP., FXD, CER DI: 1PF, (NOM VALUE), SEL * FURNISHED AS A UNIT WITH L81 AND L82. * STANDARD ONLY	72982	8101B057C0K0109B
C80	283-0181-00	B010100	B043049	CAP., FXD, CER DI: 1.8PF, 10%, 100V * FURNISHED AS A UNIT WITH L81 AND L82. * OPTION 4 ONLY	72982	8101B121C0K0189B
C80	283-0158-00	B043050		CAP., FXD, CER DI: 1PF, (NOM VALUE), SEL * FURNISHED AS A UNIT WITH L81 AND L82.	72982	8101B057C0K0109B

Replaceable Electrical Parts—7A19

Ckt No.	Tektronix Part No.	Serial/Model No. Eff	Dscont	Name & Description	Mfr Code	Mfr Part Number
C80	-----			* OPTION 4 ONLY		
C84	283-0069-00			CAP., FXD, CER DI: 15PF, 20%, 50V	72982	811-059C0G0150M
C86	283-0201-00			CAP., FXD, CER DI: 27PF, 10%, 200V	72982	8101B210X7R0270K
C88	283-0156-00			CAP., FXD, CER DI: 1000PF, +100-0%, 200V	72982	8111A208Z5U0102Z
C91	283-0182-00			CAP., FXD, CER DI: 51PF, 5%, 400V	72982	8110N400COG510J
C95	283-0182-00			CAP., FXD, CER DI: 51PF, 5%, 400V	72982	8110N400COG510J
C101	283-0182-00			CAP., FXD, CER DI: 51PF, 5%, 400V	72982	8110N400COG510J
C107	283-0182-00			CAP., FXD, CER DI: 51PF, 5%, 400V	72982	8110N400COG510J
C121	283-0160-00	B010100	B037650	CAP., FXD, CER DI: 1.5PF, 10%, 50V	72982	8101A058COK159B
C121	283-0181-00	B037651	B037849	CAP., FXD, CER DI: 1.8PF, 10%, 100V	72982	8101B121COK0189B
C121	283-0185-00	B037850		CAP., FXD, CER DI: 2.5PF, (NOM VALUE), SEL * STANDARD ONLY	72982	8101B057COK0295B
C121	283-0185-00	B043050		CAP., FXD, CER DI: 2.5PF, (NOM VALUE), SEL * OPTION 4 ONLY	72982	8101B057COK0295B
C123	283-0160-00			CAP., FXD, CER DI: 1.5PF, 10%, 50V (C123, FURNISHED AS A UNIT WITH L124 AND L125)	72982	8101A058COK159B
C162	283-0000-00			CAP., FXD, CER DI: 0.001UF, +100-0%, 500V	72982	831-516E102P
C167	283-0000-00			CAP., FXD, CER DI: 0.001UF, +100-0%, 500V	72982	831-516E102P
C168	283-0000-00			CAP., FXD, CER DI: 0.001UF, +100-0%, 500V	72982	831-516E102P
CR50	152-0141-02			SEMICONV DEVICE: SILICON, 30V, 150MA	80009	152-0141-02
CR54	152-0141-02			SEMICONV DEVICE: SILICON, 30V, 150MA	80009	152-0141-02
CR58	152-0141-02	XB039010		SEMICONV DEVICE: SILICON, 30V, 150MA	80009	152-0141-02
CR59	152-0141-02	XB039010		SEMICONV DEVICE: SILICON, 30V, 150MA	80009	152-0141-02
CR124	152-0333-00			SEMICONV DEVICE: SILICON, 55V, 200MA	80009	152-0333-00
CR125	152-0333-00			SEMICONV DEVICE: SILICON, 55V, 200MA	80009	152-0333-00
CR147	152-0141-02			SEMICONV DEVICE: SILICON, 30V, 150MA	80009	152-0141-02
DL13	119-0321-00			DELAY LINE, ELEC: (DL13, OPTION 4 ONLY)	80009	119-0321-00
F6	159-0056-00	B010100	B029999X	FUSE, CARTRIDGE: 0.1A, 125V, FAST-BLOW * STANDARD ONLY	75915	279-100
F6	159-0056-00	B010100	B039999X	FUSE, CARTRIDGE: 0.1A, 125V, FAST-BLOW * OPTION 4 ONLY	75915	279-100
F7	159-0056-00	B010100	B029999X	FUSE, CARTRIDGE: 0.1A, 125V, FAST-BLOW * STANDARD ONLY	75915	279-100
F7	159-0056-00	B010100	B039999X	FUSE, CARTRIDGE: 0.1A, 125V, FAST-BLOW * OPTION 4 ONLY	75915	279-100
F10	159-0118-00	XB030000		FUSE, THERMAL: 50 OHM * STANDARD ONLY	80009	159-0118-00
F10	159-0118-00	XB040000		FUSE, THERMAL: 50 OHM * OPTION 4 ONLY	80009	159-0118-00
J1	131-1171-00			CONNECTOR, RCPT, :BNC, 50 OHM	24931	28JR231-1
L21	283-0181-00			CAP., FXD, CER DI: 1.8PF, 10%, 100V (L21, FURNISHED AS A UNIT WITH C20, SEE SERVICE MANUAL MAINTENANCE SECTION.)	72982	8101B121COK0189B
L22	283-0181-00			CAP., FXD, CER DI: 1.8PF, 10%, 100V (L22, FURNISHED AS A UNIT WITH C20, SEE SERVICE MANUAL MAINTENANCE SECTION.)	72982	8101B121COK0189B
L27	108-0129-00	B010100	B010879	COIL, RF: 18UH	80009	108-0129-00
L27	108-0409-00	B010880		COIL, RF: 17.5UH	80009	108-0409-00
L81	283-0181-00			CAP., FXD, CER DI: 1.8PF, 10%, 100V (L81, FURNISHED AS A UNIT WITH C80.) (L81, SEE SERVICE MANUAL MAINTENANCE SECTION)	72982	8101B121COK0189B
L82	283-0181-00			CAP., FXD, CER DI: 1.8PF, 10%, 100V	72982	8101B121COK0189B

Ckt No.	Tektronix Part No.	Serial/Model No. Eff	Dscont	Name & Description	Mfr Code	Mfr Part Number
	-----			(L82, FURNISHED AS A UNIT WITH C80.)		
	-----			(L82, SEE SERVICE MANUAL MAINTENANCE SECTION)		
L124	283-0160-00			CAP., FXD, CER DI:1.5PF, 10%, 50V	72982	8101A058COK159B
	-----			(L124, FURNISHED AS A UNIT WITH C123.)		
	-----			(L124, SEE SERVICE MANUAL MAINTENANCE SECTION)		
L125	283-0160-00			CAP., FXD, CER DI:1.5PF, 10%, 50V	72982	8101A058COK159B
	-----			(L125, FURNISHED AS A UNIT WITH C123.)		
	-----			(L125, SEE SERVICE MANUAL MAINTENANCE SECTION)		
LR40	108-0412-00			COIL, RF:1.7UH(WOUND ON A 180 OHM RES.)	80009	108-0412-00
LR46	108-0412-00			COIL, RF:1.7UH(WOUND ON A 180 OHM RES.)	80009	108-0412-00
LR100	108-0412-00			COIL, RF:1.7UH(WOUND ON A 180 OHM RES.)	80009	108-0412-00
LR106	108-0412-00			COIL, RF:1.7UH(WOUND ON A 180 OHM RES.)	80009	108-0412-00
Q50	151-0220-00			TRANSISTOR: SILICON, PNP	80009	151-0220-00
Q56	151-0232-00			TRANSISTOR: SILICON, NPN, DUAL	80009	151-0232-00
Q73	151-0188-00			TRANSISTOR: SILICON, PNP	80009	151-0188-00
Q76	151-0188-00			TRANSISTOR: SILICON, PNP	80009	151-0188-00
Q130	151-0254-00	B010100	B037375	TRANSISTOR: SILICON, NPN	80009	151-0254-00
Q130	151-0281-00	B037376		TRANSISTOR: SILICON, NPN	03508	X16P4039
Q165	151-0188-00			TRANSISTOR: SILICON, PNP	80009	151-0188-00
Q168	151-0188-00			TRANSISTOR: SILICON, PNP	80009	151-0188-00
R4	321-0748-06			RES., FXD, FILM:4.95K OHM, 0.25%, 0.125W	91637	MFF1816C49500C
R7	317-0202-00	B010100	B011789	RES., FXD, CMPSN:2K OHM, 5%, 0.125W	01121	BB2025
	-----			* STANDARD ONLY		
R7	317-0302-00	B011790	B029999	RES., FXD, CMPSN:3K OHM, (NOM VALUE), SEL	01121	BB3025
	-----			* STANDARD ONLY		
R7	317-0472-00	B030000		RES., FXD, CMPSN:4.7K OHM, 5%, 0.125W	01121	BB4725
	-----			* STANDARD ONLY		
R7	317-0202-00	B010100	B019999	RES., FXD, CMPSN:2K OHM, 5%, 0.125W	01121	BB2025
	-----			* OPTION 4 ONLY		
R7	317-0302-00	B020000	B039999	RES., FXD, CMPSN:3K OHM, (NOM VALUE), SEL	01121	BB3025
	-----			* OPTION 4 ONLY		
R7	317-0472-00	B040000		RES., FXD, CMPSN:4.7K OHM, 5%, 0.125W	01121	BB4725
	-----			* OPTION 4 ONLY		
R8	324-0097-00			RES., FXD, FILM:100 OHM, 1%, 1W	75042	CCFTOP1000F
R9	324-0097-00			RES., FXD, FILM:100 OHM, 1%, 1W	75042	CCFTOP1000F
R10	307-1021-00	XB030000		ATTENUATOR: STRIP, 50 OHM, HYBRID, 2.5X	80009	307-1021-00
	-----			* STANDARD ONLY		
R10	307-1021-00	XB040000		ATTENUATOR: STRIP, 50 OHM, HYBRID, 2.5X	80009	307-1021-00
	-----			* OPTION 4 ONLY		
R11	307-1023-00	XB030000		ATTENUATOR, FXD: 50 OHM, 5X	80009	307-1023-00
	-----			* STANDARD ONLY		
R11	307-1023-00	XB040000		ATTENUATOR, FXD: 50 OHM, 5X	80009	307-1023-00
	-----			* OPTION 4 ONLY		
R12	307-1024-00	XB030000		ATTENUATOR, FXD: 50 OHM, 10X	80009	307-1024-00
	-----			* STANDARD ONLY		
R12	307-1024-00	XB040000		ATTENUATOR, FXD: 50 OHM, 10X	80009	307-1024-00
	-----			* OPTION 4 ONLY		
R24	317-0750-00	B010100	B011449	RES., FXD, CMPSN: 75 OHM, 5%, 0.125W	01121	BB7505
	-----			* STANDARD ONLY		
R24	317-0750-00	B011450		RES., FXD, CMPSN: 75 OHM, (NOM VALUE), SEL	01121	BB7505
	-----			* STANDARD ONLY		
R24	317-0750-00	B010100	B019999	RES., FXD, CMPSN: 75 OHM, 5%, 0.125W	01121	BB7505
	-----			* OPTION 4 ONLY		
R24	317-0750-00	B020000		RES., FXD, CMPSN: 75 OHM, (NOM VALUE), SEL	01121	BB7505
	-----			* OPTION 4 ONLY		

Replaceable Electrical Parts—7A19

Ckt No.	Tektronix Part No.	Serial/Model No. Eff	Dscont	Name & Description	Mfr Code	Mfr Part Number
R26	317-0361-00			RES., FXD, CMPSN: 360 OHM, 5%, 0.125W	01121	BB3615
R27	315-0181-00			RES., FXD, CMPSN: 180 OHM, (NOM VALUE), SEL	01121	CB1815
R28	315-0621-00	B010100	B037650	RES., FXD, CMPSN: 620 OHM, 5%, 0.25W	01121	CB6215
R28	315-0621-00	B037651		RES., FXD, CMPSN: 620 OHM, (NOM VALUE), SEL	01121	CB6215
R30	321-0097-00			RES., FXD, FILM: 100 OHM, 1%, 0.125W	91637	MFF1816G100ROF
R32	323-0149-00			RES., FXD, FILM: 348 OHM, 1%, 0.50W	75042	CECTO-3480F
R34	321-0097-00			RES., FXD, FILM: 100 OHM, 1%, 0.125W	91637	MFF1816G100ROF
R36	323-0149-00			RES., FXD, FILM: 348 OHM, 1%, 0.50W	75042	CECTO-3480F
R38	311-0634-00			RES., VAR, NONWIR: 500 OHM, 10%, 0.50W	73138	82-31-0
R39	301-0621-00			RES., FXD, CMPSN: 620 OHM, 5%, 0.50W	01121	EB6215
R42	323-0120-00			RES., FXD, FILM: 174 OHM, 1%, 0.50W	75042	CECTO-1740F
R44	317-0750-00			RES., FXD, CMPSN: 75 OHM, 5%, 0.125W	01121	BB7505
R45	325-0027-00			RES., FXD, FILM: 93 OHM, 1%, 0.05W	03888	PME50-C93R00F
R48	323-0120-00			RES., FXD, FILM: 174 OHM, 1%, 0.50W	75042	CECTO-1740F
R49	301-0621-00			RES., FXD, CMPSN: 620 OHM, 5%, 0.50W	01121	EB6215
R52	315-0202-00			RES., FXD, CMPSN: 2K OHM, 5%, 0.25W	01121	CB2025
R54	315-0333-00			RES., FXD, CMPSN: 33K OHM, 5%, 0.25W	01121	CB3335
R56	315-0682-00			RES., FXD, CMPSN: 6.8K OHM, 5%, 0.25W	01121	CB6825
R58	321-0193-00			RES., FXD, FILM: 1K OHM, 1%, 0.125W	91637	MFF1816G10000F
R59	315-0102-00			RES., FXD, CMPSN: 1K OHM, 5%, 0.25W	01121	CB1025
R61	321-0193-00			RES., FXD, FILM: 1K OHM, 1%, 0.125W	91637	MFF1816G10000F
R63	321-0372-00			RES., FXD, FILM: 73.2K OHM, 1%, 0.125W	91637	MFF1816G73201F
R64	321-0223-00			RES., FXD, FILM: 2.05K OHM, 1%, 0.125W	91637	MFF1816G20500F
R66	321-0372-00			RES., FXD, FILM: 73.2K OHM, 1%, 0.125W	91637	MFF1816G73201F
R67	315-0275-00			RES., FXD, CMPSN: 2.7M OHM, 5%, 0.25W	01121	CB2755
R68	311-1320-00			RES., VAR, NONWIR: 5K OHM, 1W, W/SW (R68, FURNISHED AS A UNIT WITH S70)	12697	381CM-39700
R72	322-0193-00			RES., FXD, FILM: 1K OHM, 1%, 0.25W	75042	CEBTO-1001F
R73	311-0172-00			RES., VAR, NONWIR: 2.5K OHM, 10%	12697	381-CM25200
R74	307-0250-00			RES., THERMAL: 390 OHM, 10%	15454	DG125390K
R76	311-0633-00			RES., VAR, NONWIR: 5K OHM, 10%, 0.50W	73138	82-30-0
R78	315-0101-00			RES., FXD, CMPSN: 100 OHM, 5%, 0.25W	01121	CB1015
R79	315-0101-00			RES., FXD, CMPSN: 100 OHM, 5%, 0.25W	01121	CB1015
R84	317-0750-00			RES., FXD, CMPSN: 75 OHM, 5%, 0.125W	01121	BB7505
R85	315-0181-00	XB038100		RES., FXD, CMPSN: 180 OHM, 5%, 0.25W	01121	CB1815
R86	315-0361-00			RES., FXD, CMPSN: 360 OHM, 5%, 0.25W	01121	CB3615
R88	315-0621-00			RES., FXD, CMPSN: 620 OHM, 5%, 0.25W	01121	CB6215
R90	321-0097-00			RES., FXD, FILM: 100 OHM, 1%, 0.125W	91637	MFF1816G100ROF
R92	323-0149-00			RES., FXD, FILM: 348 OHM, 1%, 0.50W	75042	CECTO-3480F
R94	321-0097-00			RES., FXD, FILM: 100 OHM, 1%, 0.125W	91637	MFF1816G100ROF
R96	323-0149-00			RES., FXD, FILM: 348 OHM, 1%, 0.50W	75042	CECTO-3480F
R98	311-0634-00			RES., VAR, NONWIR: 500 OHM, 10%, 0.50W	73138	82-31-0
R99	301-0621-00			RES., FXD, CMPSN: 620 OHM, 5%, 0.50W	01121	EB6215
R102	323-0120-00			RES., FXD, FILM: 174 OHM, 1%, 0.50W	75042	CECTO-1740F
R104	317-0750-00			RES., FXD, CMPSN: 75 OHM, 5%, 0.125W	01121	BB7505
R105	325-0027-00			RES., FXD, FILM: 93 OHM, 1%, 0.05W	03888	PME50-C93R00F
R108	323-0120-00			RES., FXD, FILM: 174 OHM, 1%, 0.50W	75042	CECTO-1740F
R109	301-0621-00			RES., FXD, CMPSN: 620 OHM, 5%, 0.50W	01121	EB6215
R110	321-0222-00			RES., FXD, FILM: 2K OHM, 1%, 0.125W	91637	MFF1816G20000F
R112	321-0385-00			RES., FXD, FILM: 100K OHM, 1%, 0.125W	91637	MFF1816G10002F
R114	315-0242-00			RES., FXD, CMPSN: 2.4K OHM, 5%, 0.25W	01121	CB2425
R116	311-1007-00			RES., VAR, NONWIR: 20 OHM, 20%, 0.50W	73138	82-38-0
R117	317-0202-00			RES., FXD, CMPSN: 2K OHM, (NOM VALUE), SEL	01121	BB2025
R119	321-0067-00			RES., FXD, FILM: 48.7 OHM, 1%, 0.125W	91637	MFF1816G48R70F
R121	317-0121-00	B010100	B037650	RES., FXD, CMPSN: 120 OHM, 5%, 0.125W	01121	BB1215
R121	317-0121-00	B037651		RES., FXD, CMPSN: 120 OHM, (NOM VALUE), SEL	01121	BB1215

Ckt No.	Tektronix Part No.	Serial/Model No. Eff	Dscont	Name & Description	Mfr Code	Mfr Part Number
R132	321-0299-00			RES., FXD, FILM: 12.7K OHM, 1%, 0.125W	91637	MFF1816G12701F
R133	315-0753-00			RES., FXD, CMPSN: 75K OHM, 5%, 0.25W	01121	CB7535
R134	315-0753-00			RES., FXD, CMPSN: 75K OHM, 5%, 0.25W	01121	CB7535
R135	315-0154-00			RES., FXD, CMPSN: 150K OHM, 5%, 0.25W	01121	CB1545
R137	315-0154-00			RES., FXD, CMPSN: 150K OHM, 5%, 0.25W	01121	CB1545
R138	321-0344-00			RES., FXD, FILM: 37.4K OHM, 1%, 0.125W	91637	MFF1816G37401F
R139	315-0753-00			RES., FXD, CMPSN: 75K OHM, 5%, 0.25W	01121	CB7535
R141	315-0154-00			RES., FXD, CMPSN: 150K OHM, 5%, 0.25W	01121	CB1545
R142	315-0513-00			RES., FXD, CMPSN: 51K OHM, 5%, 0.25W	01121	CB5135
R144	315-0753-00			RES., FXD, CMPSN: 75K OHM, 5%, 0.25W	01121	CB7535
R145	321-0344-00			RES., FXD, FILM: 37.4K OHM, 1%, 0.125W	91637	MFF1816G37401F
R147	315-0154-00			RES., FXD, CMPSN: 150K OHM, 5%, 0.25W	01121	CB1545
R148	315-0154-00			RES., FXD, CMPSN: 150K OHM, 5%, 0.25W	01121	CB1545
R163	311-0634-00			RES., VAR, NONWIR: 500 OHM, 10%, 0.50W	73138	82-31-0
R164	322-0212-00			RES., FXD, FILM: 1.58K OHM, 1%, 0.25W	75042	CEBT0-1581F
R166	321-0193-00			RES., FXD, FILM: 1K OHM, 1%, 0.125W	91637	MFF1816G10000F
R168	315-0102-00			RES., FXD, CMPSN: 1K OHM, 5%, 0.25W	01121	CB1025
R171	315-0510-00			RES., FXD, CMPSN: 51 OHM, 5%, 0.25W	01121	CB5105
R173	315-0510-00			RES., FXD, CMPSN: 51 OHM, 5%, 0.25W	01121	CB5105
R178	315-0470-00			RES., FXD, CMPSN: 47 OHM, 5%, 0.25W	01121	CB4705
S5	105-0321-00	B010100	B029999	ACTR ASSY, CAM S: INPUT * STANDARD ONLY	80009	105-0321-00
S5	263-1094-00	B030000		SW CAM ACTR AS: INPUT * STANDARD ONLY	80009	263-1094-00
S5	105-0321-00	B010100	B039999	ACTR ASSY, CAM S: INPUT * OPTION 4 ONLY	80009	105-0321-00
S5	263-1094-00	B040000		SW CAM ACTR AS: INPUT * OPTION 4 ONLY	80009	263-1094-00
S10	263-1064-00	XB030000		SW CAM ACTR AS: VOLTS/DIV * STANDARD ONLY	80009	263-1064-00
S10	263-1064-00	XB040000		SW CAM ACTR AS: VOLTS/DIV * OPTION 4 ONLY	80009	263-1064-00
S50	105-0322-00	B010100	B029999	ACTR ASSY, CAM S: POLARITY * STANDARD ONLY	80009	105-0322-00
S50	263-1095-00	B030000		SW CAM ACTR AS: POLARITY * STANDARD ONLY	80009	263-1095-00
S50	105-0322-00	B010100	B039999	ACTR ASSY, CAM S: POLARITY * OPTION 4 ONLY	80009	105-0322-00
S50	263-1095-00	B040000		SW CAM ACTR AS: POLARITY * OPTION 4 ONLY	80009	263-1095-00
S70	311-1320-00			RES., VAR, NONWIR: 5K OHM, 1W, W/SW (S70, FURNISHED AS A UNIT WITH R68)	12697	381CM-39700
S135	105-0323-00	B010100	B029999	ACTR ASSY, CAM S: VOLTS/DIV * STANDARD ONLY	80009	105-0323-00
S135	263-1096-00	B030000		SW CAM ACTR AS: VOLTS/DIV * STANDARD ONLY	80009	263-1096-00
S135	105-0323-00	B010100	B039999	ACTR ASSY, CAM S: VOLTS/DIV * OPTION 4 ONLY	80009	105-0323-00
S135	263-1096-00	B040000		SW CAM ACTR AS: VOLTS/DIV * OPTION 4 ONLY	80009	263-1096-00
U40	155-0068-00			MICROCIRCUIT, LI: HYBRID, AMPLIFIER	80009	155-0068-00
U100	155-0068-00			MICROCIRCUIT, LI: HYBRID, AMPLIFIER	80009	155-0068-00
U110	156-0049-00			MICROCIRCUIT, LI: OPERATIONAL AMPLIFIER	80009	156-0049-00

DIAGRAMS

Symbols and Reference Designators

Electrical components shown on the diagrams are in the following units unless noted otherwise:

- Capacitors = Values one or greater are in picofarads (pF).
Values less than one are in microfarads (μ F).
- Resistors = Ohms (Ω).

Symbols used on the diagrams are based on ANSI Standard Y32.2-1970.

Logic symbology is based on ANSI Y32.14-1973 in terms of positive logic. Logic symbols depict the logic function performed and may differ from the manufacturer's data.

The following prefix letters are used as reference designators to identify components or assemblies on the diagrams.

A	Assembly, separable or repairable (circuit board, etc.)	H	Heat dissipating device (heat sink, heat radiator, etc.)	RT	Thermistor
AT	Attenuator, fixed or variable	HR	Heater	S	Switch
B	Motor	HY	Hybrid circuit	T	Transformer
BT	Battery	J	Connector, stationary portion	TC	Thermocouple
C	Capacitor, fixed or variable	K	Relay	TP	Test point
CB	Circuit breaker	L	Inductor, fixed or variable	U	Assembly, inseparable or non-repairable (integrated circuit, etc.)
CR	Diode, signal or rectifier	LR	Inductor/resistor combination	V	Electron tube
DL	Delay line	M	Meter	VR	Voltage regulator (zener diode, etc.)
DS	Indicating device (lamp)	P	Connector, movable portion	Y	Crystal
E	Spark Gap	Q	Transistor or silicon-controlled rectifier	Z	Phase shifter
F	Fuse	R	Resistor, fixed or variable		
FL	Filter				

The following special symbols are used on the diagrams:

- Cam Switch Closure Chart
- Internal Screwdriver Adjustment
- Test Voltage
- Plug to E.C. Board
- Panel Adjustment
- Plug Index
- Modified Component—See Parts List
- Refer to Waveform
- Refer to Diagram Number
- SEL Value Selected at Factory
- Coaxial Connector
- Panel Connector
- Assembly Number
- Board Name
- Etched Circuit Board Outlined in Black
- Schematic Name and Number

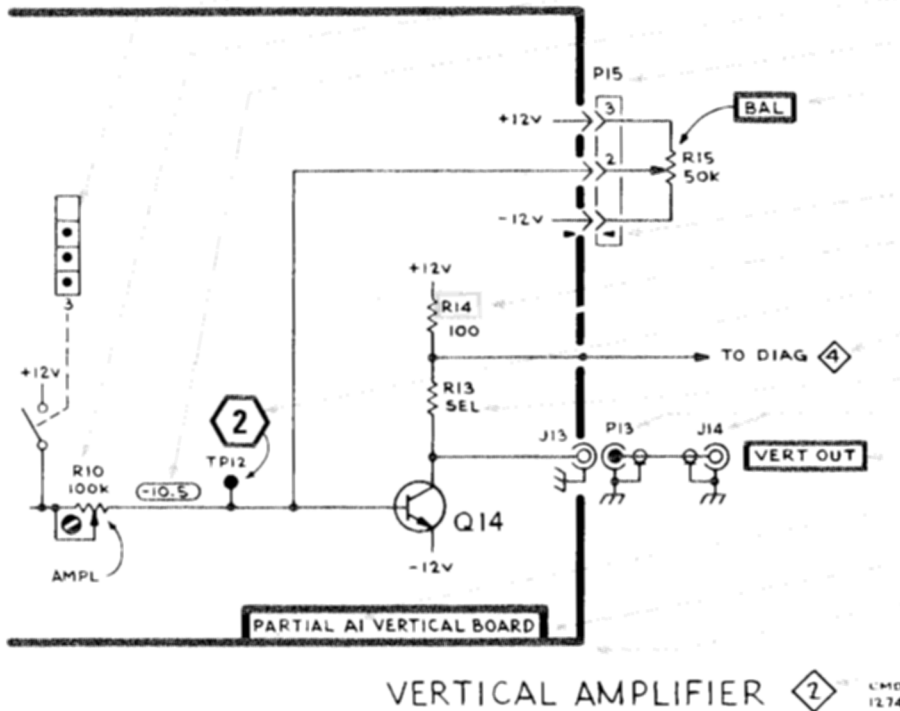

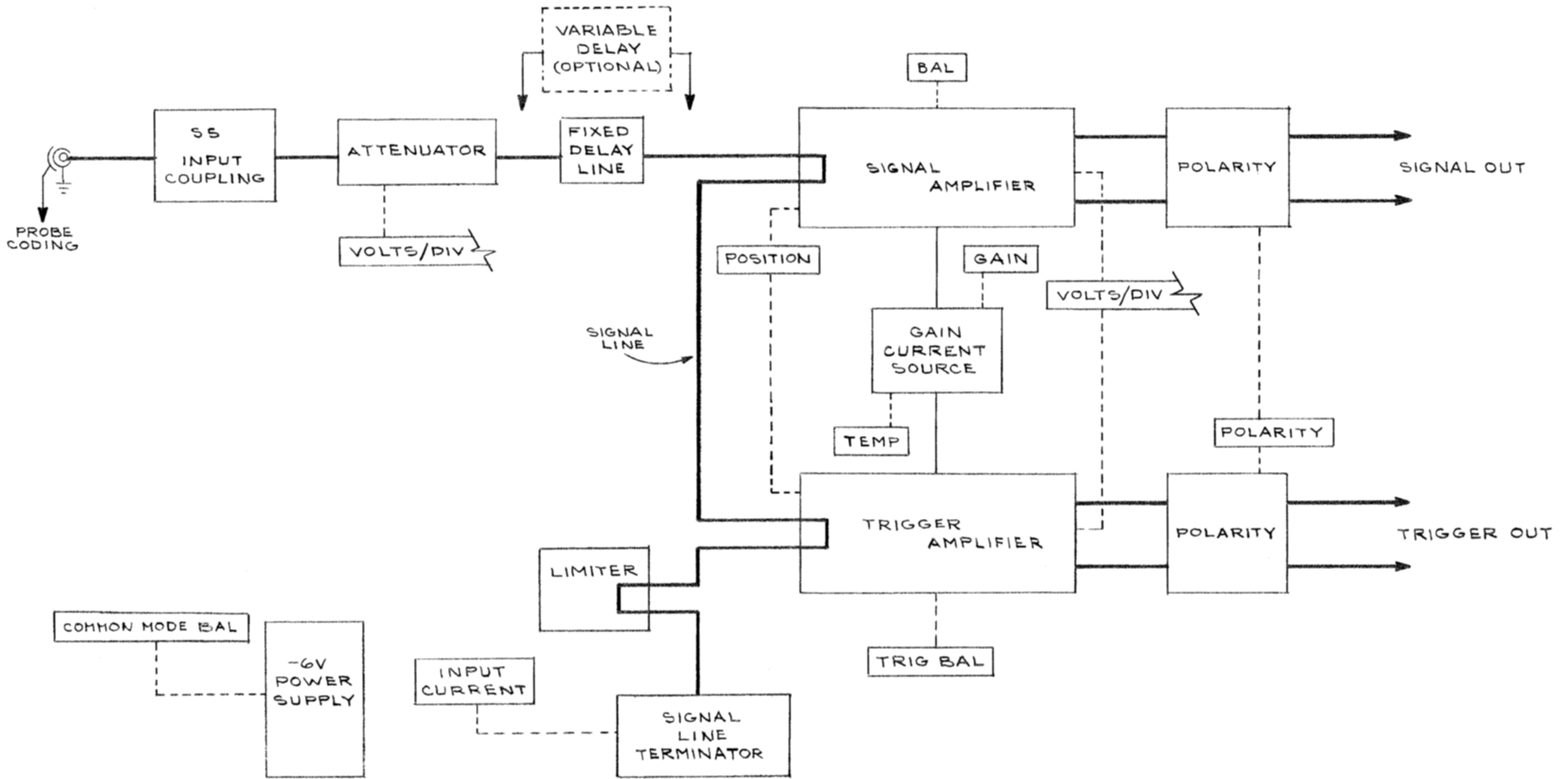

7A19

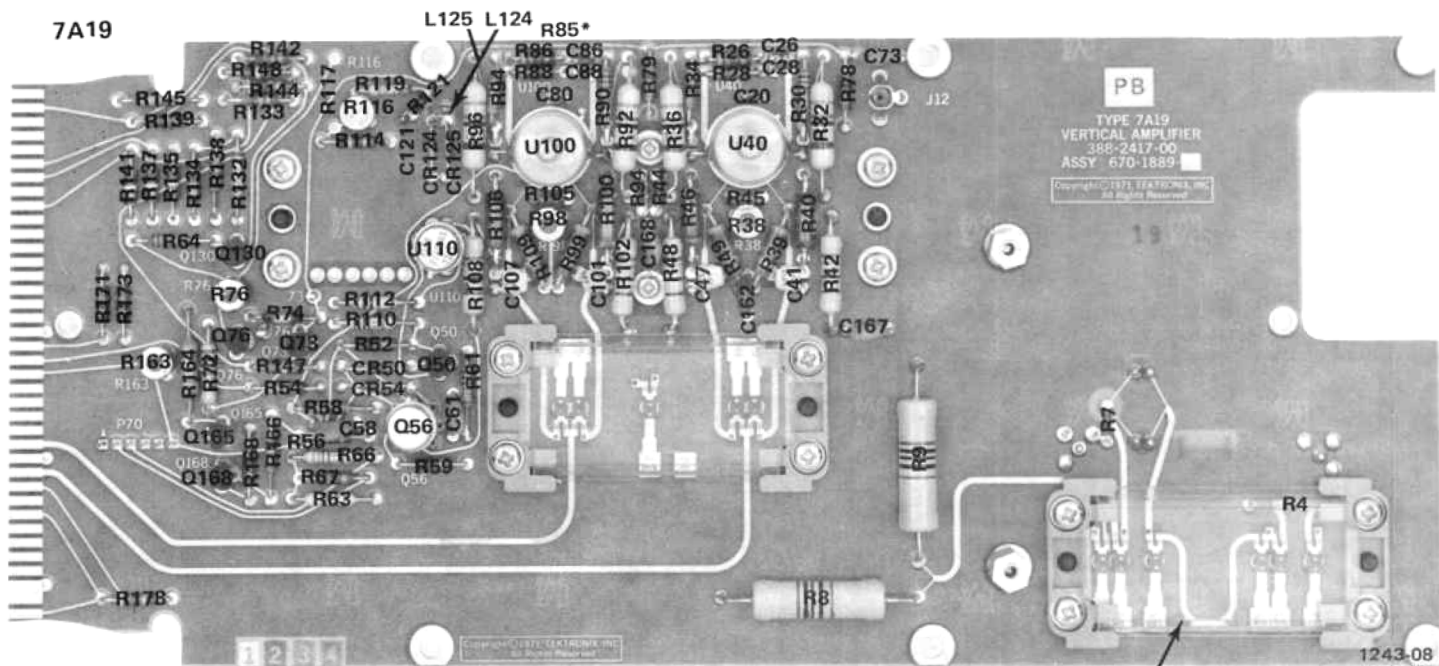

Attenuator circuit board assembly below SN B030000.

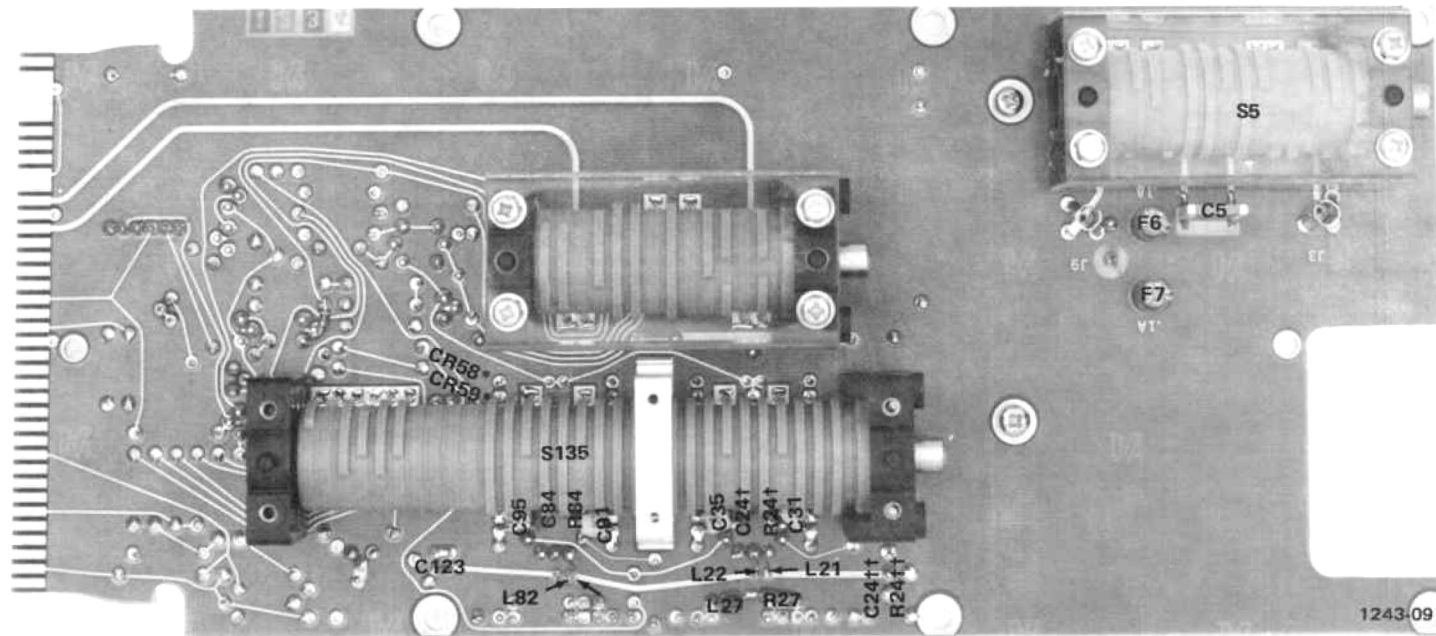

* See Parts List for serial

VOLTAGE AND WAVEFORM TEST CONDITIONS

Typical voltage measurements were obtained under the following conditions unless noted otherwise on the individual diagrams:

Voltmeter

Type	Non-loading digital multimeter
Input impedance	10 M Ω
Range	0 to 1000 volts
Recommended type (as used for voltages on diagrams)	Tektronix DM501 Digital Multimeter

7A19 (left vertical compartment)

POLARITY	+UP
VOLTS/DIV	10 mV
COUPLING	DC
POSITION	Centered
Signal Applied	No signal for voltage measurements, 40 mV square wave from oscilloscope Calibrator applied to input connector for waveforms.

7A16A (right vertical compartment using a 10X probe with readout coding ring. P6062A probe used for waveforms on diagrams)

Polarity	+UP
Bandwidth	Full
Position	Centered
Coupling	AC
Variable	Cal In

7B70 (A Horizontal compartment)

Level/Slope	Centered on positive slope
Triggering Mode	P-P Auto
Coupling	AC
Source	Ext
Magnifier	X1
Time/Div	1 ms
Variable	Cal In

7704A

Vertical Mode	Right
Horizontal Mode	A
A Intensity	Optimum
B Intensity	Counterclockwise
Calibrator	
Volts	40 mV
Rate	1 kHz
A Trigger Source	Right Vert
B Trigger Source	Left Vert

All voltages given on the diagrams are in volts. All currents are in milliamps. Waveforms shown are actual waveform photographs taken with a Tektronix Oscilloscope Camera System. Vertical deflection factor shown on waveform is the actual deflection factor from the probe tip. Voltages and waveforms on the diagrams (shown in blue) are not absolute and may vary between instruments because of component tolerances, internal calibration or front panel settings.

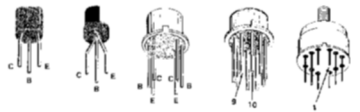

SWITCH SHOWN IN GND 100V DC POSITION
 ● INDICATES "B" CONTACTS CLOSED

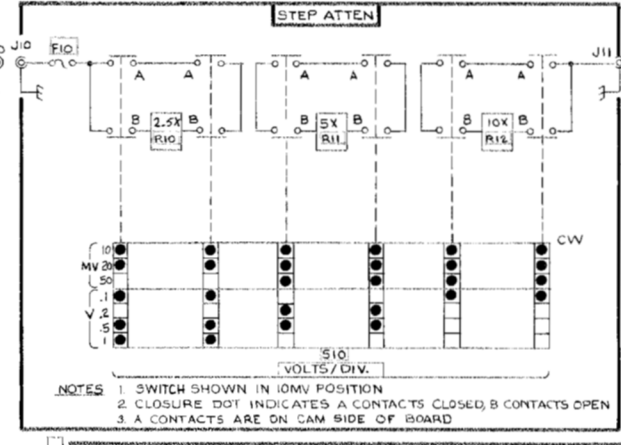
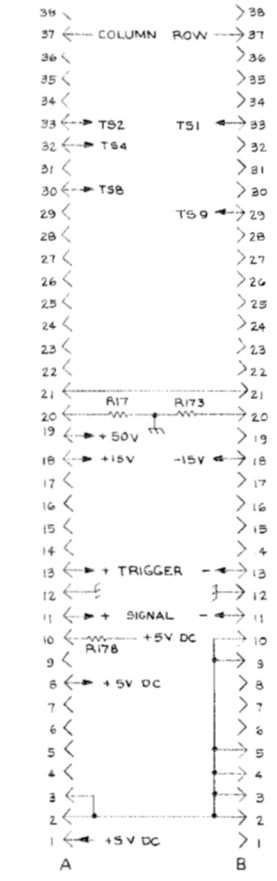
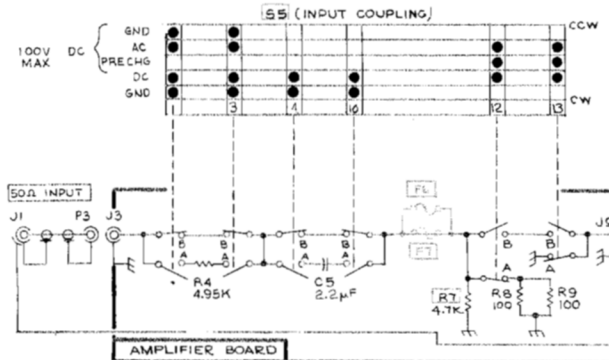

NOTES
 1. SWITCH SHOWN IN 10MV POSITION
 2. CLOSURE DOT INDICATES A CONTACTS CLOSED, B CONTACTS OPEN
 3. A CONTACTS ARE ON CAM SIDE OF BOARD

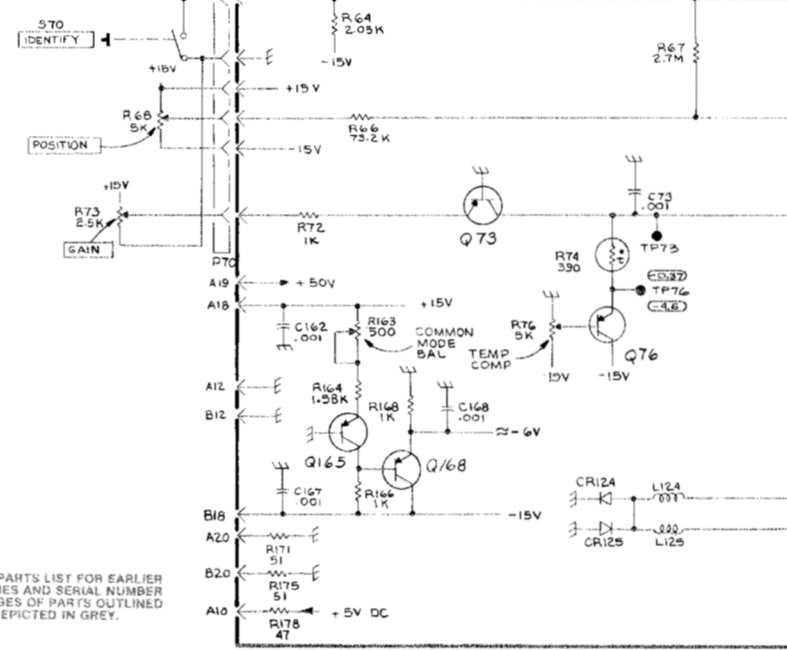

SEE PARTS LIST FOR EARLIER VALUES AND SERIAL NUMBER RANGES OF PARTS OUTLINED OR DEPICTED IN GREY.

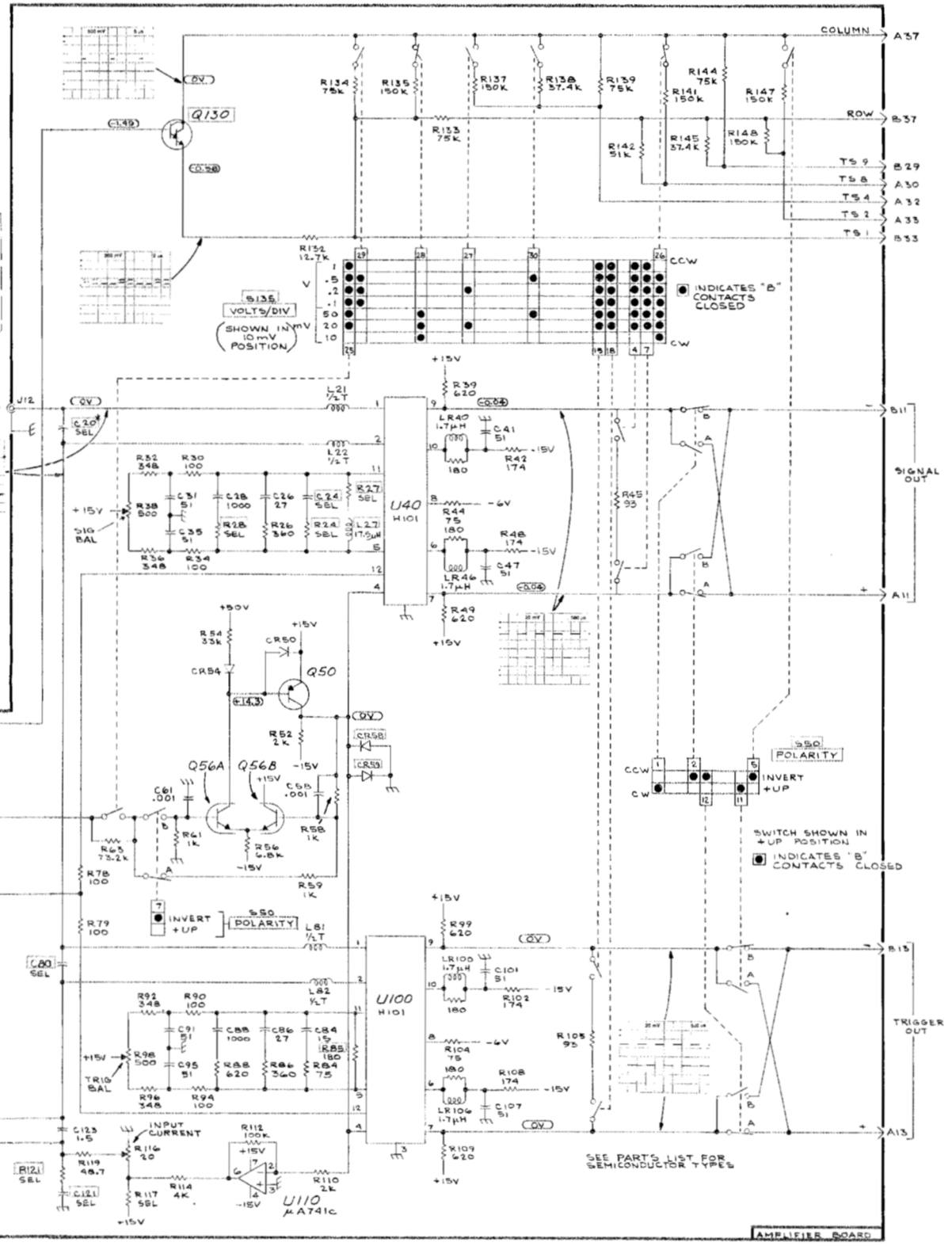
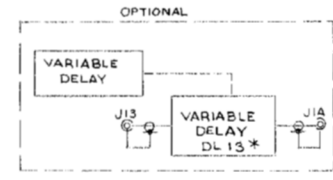

● INDICATES "B" CONTACTS CLOSED

● INDICATES "B" CONTACTS CLOSED

SEE PARTS LIST FOR SEMICONDUCTOR TYPES

REPLACEABLE MECHANICAL PARTS

PARTS ORDERING INFORMATION

Replacement parts are available from or through your local Tektronix, Inc. Field Office or representative.

Changes to Tektronix instruments are sometimes made to accommodate improved components as they become available, and to give you the benefit of the latest circuit improvements developed in our engineering department. It is therefore important, when ordering parts, to include the following information in your order: Part number, instrument type or number, serial number, and modification number if applicable.

If a part you have ordered has been replaced with a new or improved part, your local Tektronix, Inc. Field Office or representative will contact you concerning any change in part number.

Change information, if any, is located at the rear of this manual.

SPECIAL NOTES AND SYMBOLS

X000 Part first added at this serial number
00X Part removed after this serial number

FIGURE AND INDEX NUMBERS

Items in this section are referenced by figure and index numbers to the illustrations.

INDENTATION SYSTEM

This mechanical parts list is indented to indicate item relationships. Following is an example of the indentation system used in the description column.

```

1 2 3 4 5           Name & Description
Assembly and/or Component
Attaching parts for Assembly and/or Component
    - - - * - - -
Detail Part of Assembly and/or Component
Attaching parts for Detail Part
    - - - * - - -
Parts of Detail Part
Attaching parts for Parts of Detail Part
    - - - * - - -
  
```

Attaching Parts always appear in the same indentation as the item it mounts, while the detail parts are indented to the right. Indented items are part of, and included with, the next higher indentation. The separation symbol - - - * - - - indicates the end of attaching parts.

Attaching parts must be purchased separately, unless otherwise specified.

ITEM NAME

In the Parts List, an Item Name is separated from the description by a colon (:). Because of space limitations, an Item Name may sometimes appear as incomplete. For further Item Name identification, the U.S. Federal Cataloging Handbook H6-1 can be utilized where possible.

ABBREVIATIONS

..	INCH	ELCTRN	ELECTRON	IN	INCH	SE	SINGLE END
#	NUMBER SIZE	ELEC	ELECTRICAL	INCAND	INCANDESCENT	SECT	SECTION
ACTR	ACTUATOR	ELCTLT	ELECTROLYTIC	INSUL	INSULATOR	SEMICON	SEMICONDUCTOR
ADPTR	ADAPTER	ELEM	ELEMENT	INTL	INTERNAL	SHLD	SHIELD
ALIGN	ALIGNMENT	EPL	ELECTRICAL PARTS LIST	LPHLDR	LAMPHOLDER	SHLDR	SHOULDERED
AL	ALUMINUM	EQPT	EQUIPMENT	MACH	MACHINE	SKT	SOCKET
ASSEM	ASSEMBLED	EXT	EXTERNAL	MECH	MECHANICAL	SL	SLIDE
ASSY	ASSEMBLY	FIL	FILLISTER HEAD	MTG	MOUNTING	SLFLKG	SELF-LOCKING
ATTEN	ATTENUATOR	FLEX	FLEXIBLE	NIP	NIPPLE	SLVG	SLEEVING
AWG	AMERICAN WIRE GAGE	FLH	FLAT HEAD	NON WIRE	NOT WIRE WOUND	SPR	SPRING
BD	BOARD	FLTR	FILTER	OBD	ORDER BY DESCRIPTION	SQ	SQUARE
BRKT	BRACKET	FR	FRAME or FRONT	OD	OUTSIDE DIAMETER	SST	STAINLESS STEEL
BRS	BRASS	FSTNR	FASTENER	OVH	OVAL HEAD	STL	STEEL
BRZ	BRONZE	FT	FOOT	PH BRZ	PHOSPHOR BRONZE	SW	SWITCH
BSHG	BUSHING	FXD	FIXED	PL	PLAIN or PLATE	T	TUBE
CAB	CABINET	GSKT	GASKET	PLSTC	PLASTIC	TERM	TERMINAL
CAP	CAPACITOR	HDL	HANDLE	PN	PART NUMBER	THD	THREAD
CER	CERAMIC	HEX	HEXAGON	PNH	PAN HEAD	THK	THICK
CHAS	CHASSIS	HEX HD	HEXAGONAL HEAD	PWR	POWER	TNSN	TENSION
CKT	CIRCUIT	HEX SOC	HEXAGONAL SOCKET	RCPT	RECEPTACLE	TPG	TAPPING
COMP	COMPOSITION	HLCPS	HELICAL COMPRESSION	RES	RESISTOR	TRH	TRUSS HEAD
CONN	CONNECTOR	HLEXT	HELICAL EXTENSION	RGD	RIGID	V	VOLTAGE
COV	COVER	HV	HIGH VOLTAGE	RLF	RELIEF	VAR	VARIABLE
CPLG	COUPLING	IC	INTEGRATED CIRCUIT	RTNR	RETAINER	W/	WITH
CRT	CATHODE RAY TUBE	ID	INSIDE DIAMETER	SCH	SOCKET HEAD	WSHR	WASHER
DEG	DEGREE	IDENT	IDENTIFICATION	SCOPE	OSCILLOSCOPE	XFMR	TRANSFORMER
DWR	DRAWER	IMPLR	IMPELLER	SCR	SCREW	XSTR	TRANSISTOR

CROSS INDEX—MFR. CODE NUMBER TO MANUFACTURER

Mfr. Code	Manufacturer	Address	City, State, Zip
000CN	OMNI-SPECTRA, INC., AMERICON CABLE DIV.	2370 OWN STREET	SANTA CLARA, CA 95050
000CY	NORTHWEST FASTENER SALES, INC.	7923 SW CIRRUS DRIVE	BEAVERTON, OREGON 97005
00779	AMP, INC.	P O BOX 3608	HARRISBURG, PA 17105
08261	SPECTRA-STRIP CORP.	7100 LAMPSON AVE.	GARDEN GROVE, CA 92642
12360	ALBANY PRODUCTS CO., DIV. OF PNEUMO DYNAMICS CORPORATION	145 WOODWARD AVENUE	SOUTH NORWALK, CT 06586
13257	AMERACE, LTD.	10 ESNA PARK DRIVE	MARKHAM, ONTARIO, CANADA
22526	BERG ELECTRONICS, INC.	YOUK EXPRESSWAY	NEW CUMBERLAND, PA 17070
24931	SPECIALTY CONNECTOR CO., INC.	3560 MADISON AVE.	INDIANAPOLIS, IN 46227
26805	OMNI SPECTRA INC., MICROWAVE CONNECTOR DIV.	140 FOURTH AVE	WALTHAM, MA 02154
42838	NATIONAL RIVET AND MFG. CO.	1-21 EAST JEFFERSON ST.	WAUPUN, WI 53963
71785	TRW, CINCH CONNECTORS	1501 MORSE AVENUE	ELK GROVE VILLAGE, IL 60007
73743	FISCHER SPECIAL MFG. CO.	446 MORGAN ST.	CINCINNATI, OH 45206
74445	HOLO-KROME CO.	31 BROOK ST. WEST	HARTFORD, CT 06110
78189	ILLINOIS TOOL WORKS, INC. SHAKEPROOF DIVISION	ST. CHARLES ROAD	ELGIN, IL 60120
79136	WALDES, KOHINOOR, INC.	47-16 AUSTEL PLACE	LONG ISLAND CITY, NY 11101
80009	TEKTRONIX, INC.	P O BOX 500	BEAVERTON, OR 97077
83385	CENTRAL SCREW CO.	2530 CRESCENT DR.	BROADVIEW, IL 60153
87308	N. L. INDUSTRIES, INC., SOUTHERN SCREW DIV.	P. O. BOX 1360	STATESVILLE, NC 28677
93459	WEINSCHEL ENGINEERING COMPANY, INC.	CLOPPER ROAD, P O BOX 577	GAITHERSBURG, MD 20760
97464	INDUSTRIAL RETAINING RING CO.	57 CORDIER ST.	IRVINGTON, NJ 07111
98291	SEAELECTRO CORP.	225 HOYT	MAMARONECK, NY 10544

Fig. & Index No.	Tektronix Part No.	Serial/Model No. Eff	Dscont	Qty	1	2	3	4	5	Name & Description	Mfr Code	Mfr Part Number
1-1	337-1064-04			2						SHIELD,ELEC:RIGHT SIDE	80009	337-1064-00
-2	366-1059-00			1						PUSH BUTTON:GRAY	80009	366-1059-00
-3	366-1077-00			1						KNOB:GRAY	80009	366-1077-00
	213-0153-00			1						. SETSCREW:5-40 X 0.125,STL BK OXD,HEX	000CY	OBD
-4	366-1028-00			1						KNOB:GRAY	80009	366-1028-00
	213-0153-00			2						. SETSCREW:5-40 X 0.125,STL BK OXD,HEX	000CY	OBD
-5	366-1209-00			1						KNOB:GRAY	80009	366-1209-00
	213-0153-00			1						. SETSCREW:5-40 X 0.125,STL BK OXD,HEX	000CY	OBD
-6	366-1209-00			1						KNOB:GRAY	80009	366-1209-00
	213-0153-00			1						. SETSCREW:5-40 X 0.125,STL BK OXD,HEX	000CY	OBD
-7	366-1058-31			1						KNOB:LATCH	80009	366-1058-31
										(ATTACHING PARTS)		
-8	214-1095-00			1						PIN,SPG,SPLIT:0.094 OD X 0.187 INCH LONG	13257	52-022-094-0187
										- - - * - - -		
-9	-----			1						RESISTOR,VAR:(SEE R68 EPL)		
										(ATTACHING PARTS)		
-10	210-0583-00			1						NUT,PLAIN,HEX.:0.25-32 X 0.312 INCH,BRS	73743	2X20224-402
-11	210-0046-00			1						WASHER,LOCK:INTL,0.26 ID X 0.40" OD,STL	78189	1214-05-00-0541C
										- - - * - - -		
-12	-----			1						RESISTOR,VAR:(SEE R73 EPL)		
										(ATTACHING PARTS)		
-13	358-0342-00			1						BSHG,MACH.THD:0.25 X 32 X 0.352 INCH LONG	80009	358-0342-00
-14	210-0046-00			1						WASHER,LOCK:INTL,0.26 ID X 0.40" OD,STL	78189	1214-05-00-0541C
-15	129-0252-00			1						SPACER,POST:0.45 LONG X 0.312 HEX	80009	129-0252-00
										- - - * - - -		
-16	131-1171-00			1						CONNECTOR,RCPT,:BNC,50 OHM	24931	28JR231-1
-17	119-0319-00	B010100	B029999	1						ATTENUATOR,VAR:	93459	2980-2
	672-0430-00	B030000		1						CKT BOARD ASSY:ATTENUATOR	80009	672-0430-00
										(ATTACHING PARTS)		
-18	213-0022-00	B010100	B029999X	2						SETSCREW:4-40 X 0.188 INCH,HEX SOC STL	74445	OBD
-19	210-0590-00	B010100	B029999	1						NUT,PLAIN,HEX.:0.375 X 0.438 INCH,STL	73743	2X28269-402
	220-0495-00	B030000		1						NUT,PLAIN,HEX.:0.375-32 X 0.438 INCH BRS	73743	OBD
										- - - * - - -		
	-----			-						. CKT BOARD ASSY INCLUDES:		
-20	337-1418-01	B030000		2						. SHIELD,ELEC:CAM SWITCH	80009	337-1418-01
										(ATTACHING PARTS FOR EACH)		
-21	211-0001-00	B030000		1						. SCREW,MACHINE:2-56 X 0.25 INCH,PNH STL	83385	OBD
-22	210-0053-00	B030000		1						. WASHER,LOCK:INTL,0.092 ID X 0.175"OD,STL	83385	OBD
-23	210-1008-00	B030000		1						. WASHER,FLAT:0.09 ID X 0.188" OD,BRS	12360	OBD
										- - - * - - -		
-24	344-0248-00	B030000		4						. CLIP,ATTENUATOR:	80009	344-0248-00
-25	-----	B030000		1						. CKT BOARD ASSY:ATTENUATOR(SEE A2 EPL)		
										(ATTACHING PARTS)		
-26	211-0116-00	B030000		4						. SCR,ASSEM WSHR:4-40 X 0.312 INCH,PNH BRS	83385	OBD
										- - - * - - -		
	-----			-						. . . CKT BOARD ASSY INCLUDES:		
-27	131-1003-00	B030000		1						. . . CONNECTOR BODY,:CKT BD MT,2 PRONG	80009	131-1003-00
-28	131-1031-00	B030000		6						. . . CONTACT ASSY,EL:CAM SWITCH, TOP	80009	131-1031-00
	131-1030-00	B030000		6						. . . CONT ASSY,ELEC:CAM SWITCH,BOTTOM	80009	131-1030-00
-29	136-0252-01	B030000		2						. . . CONTACT,ELEC:0.178 INCH LONG	00779	1-332095-2
-30	210-0779-00	B030000		6						. . . RIVET,TUBULAR:0.051 OD X 0.115 INCH LONG	42838	RA-29952715
-31	214-1797-00	B030000		8						. . . PIN,ATTEN CLIP:	80009	214-1797-00
	263-1064-00	B030000		1						. SW CAM ACTR AS:VOLTS/DIVISION	80009	263-1064-00
-32	200-1653-00	B030000		1						. . . COVER,CAM SW:	80009	200-1653-00
										(ATTACHING PARTS)		
	-----			-						. . . CKT BOARD ASSY INCLUDES:		
-33	211-0022-00	B030000		2						. . . SCREW,MACHINE:2-56 X 0.25 INCH,PNH STL	83385	OBD
-34	210-0001-00	B030000		2						. . . WASHER,LOCK:INTL,0.092 ID X 0.18"OD,STL	78189	1202-00
										- - - * - - -		
-402	-35	210-0405-00	B030000	1						. . . NUT,PLAIN,HEX.:2-56 X 0.188 INCH,BRS	73743	2X12157
-402	-36	210-0406-00	B030000	2						. . . NUT,PLAIN,HEX.:4-40 X 0.188 INCH,BRS	73743	2X12161
6-00	-37	214-1126-02	B030000	2						. . . SPRING,FLAT:RED COLORED	80009	214-112
7-00	-38	214-1127-00	B030300	1						. . . ROLLER,DETENT:0.125 DIA X 0.125 INCH L	80009	214-112
3-00	-39	401-0053-00	B030000	1						. . . BEARING,CAM SW:FRONT,W/0.375-32 EXT THD	80009	401-005
										(ATTACHING PARTS)		
-MD-R	-40	354-0219-00	B030000	1						. . . RING,RETAINING:FOR 0.25 INCH SHAFT	79136	5103-25
										- - - * - - -		

Replaceable Mechanical Parts—7A19

Fig. & Index No.	Tektronix Part No.	Serial/Model No. Eff Dscont	Qty	1 2 3 4 5	Name & Description	Mfr Code	Mfr Part Number
1-41	105-0560-00	B030000	1	.	ACTUATOR,CAM SW:ATTENUATOR	80009	105-0560-00
-42	210-0405-00	B030000	1	.	NUT,PLAIN,HEX.:2-56 X 0.188 INCH,BRS	73743	2X12157-402
-43	210-0406-00	B030000	2	.	NUT,PLAIN,HEX.:4-40 X 0.188 INCH,BRS	73743	2X12161-402
-44	401-0061-00	B030000	1	.	BEARING,CAM SW:REAR	80009	401-0061-00
-45	210-0976-00	B010100 B029999X	1	.	WASHER,FLAT:0.390 ID X 0.562 OD	80009	210-0976-00
-46	358-0448-00	B010100 B029999X	1	.	BSHG,MACH THD:	80009	358-0448-00
-47	384-1126-00	B010100 B029999X	1	.	EXTENSION SHAFT:	80009	384-1126-00
-48	376-0051-00		1	.	CPLG,SHAFT,FLEX:FOR 0.125 INCH DIA SHAFTS	80009	376-0051-00
-49	384-0421-00	B010100 B029999	1	.	EXTENSION SHAFT:2.85 LONG X 0.1247 OD SST	80009	384-0421-00
	384-1240-00	B030000	1	.	EXTENSION SHAFT:2.5 LONG X 0.125 OD	80009	384-1240-00
-50	376-0052-00		1	.	CPLG,SHAFT,FLEX:FOR 0.125 X 0.25 INCH SHAFT	80009	376-0052-00
-51	333-1543-00		1	.	PANEL,FRONT:	80009	333-1543-00
-52	348-0031-00		2	.	GROMMET,PLASTIC:0.156 INCH DIA	80009	348-0031-00
-53	348-0235-00		2	.	SHLD GSKT,ELEC:4.734 INCH LONG	80009	348-0235-00
-54	386-1447-59	B010100 B029999	1	.	SUBPANEL,FRONT:	80009	386-1447-59
	386-1447-77	B030000	1	.	SUBPANEL,FRONT:	80009	386-1447-77
					(ATTACHING PARTS)		
-55	213-0192-00		4	.	SCR,TPG,THD FOR:6-32 X 0.50 INCH,PNH STL	87308	OBD
					-----*		
-56	105-0076-02		1	.	REL BAR,LATCH:PLUG-IN UNIT	80009	105-0076-02
-57	214-1280-00		1	.	SPRING,HLCPS:0.14 OD X 1.126"L,0.16"DIA W	80009	214-1280-00
-58	214-1054-00		1	.	SPRING,FLAT:0.825 X 0.322,SST	80009	214-1054-00
-59	105-0075-00		1	.	PAWL:0.475 X 0.21 X 0.184 INCH,PLSTC	80009	105-0075-00
-60	386-1402-00		1	.	PANEL,REAR:	80009	386-1402-00
					(ATTACHING PARTS)		
-61	213-0192-00		4	.	SCR,TPG,THD FOR:6-32 X 0.50 INCH,PNH STL	87308	OBD
-62	361-0326-00		1	.	SPACER,SLEEVE:0.18 ID X 0.25 OD X 0.10"L	80009	361-0326-00
					-----*		
-63	-----		2	.	INTEGRATED CKT:		
					(ATTACHING PARTS)		
-64	220-0410-00		1	.	NUT,EXTENDED WA:10-32 X 0.375 INCH,STL	83385	OBD
					-----*		
-65	214-1653-00		1	.	HEAT SINK,ELEC:	80009	214-1653-00
					(ATTACHING PARTS)		
-66	210-0586-00		2	.	NUT,PLAIN,EXT W:4-40 X 0.25 INCH,STL	78189	211-041800-00
-67	211-0101-00		2	.	SCREW,MACHINE:4-40 X 0.25" 100 DEG,FLH STL	83385	OBD
					-----*		
-68	214-1061-00		1	.	SPRING,GROUND:FLAT	80009	214-1061-00
-69	426-0505-13		1	.	FR SECT,PLUG-IN:TOP	80009	426-0505-13
					(ATTACHING PARTS)		
-70	211-0105-00		3	.	SCREW,MACHINE:4-40 X 0.188"100 DEG,FLH STL	83385	OBD
					-----*		
-71	426-0499-07		1	.	FR SECT,PLUG-IN:BOTTOM	80009	426-0499-07
					(ATTACHING PARTS)		
-72	211-0105-00		3	.	SCREW,MACHINE:4-40 X 0.188"100 DEG,FLH STL	83385	OBD
					-----*		
-73	220-0547-01		6	.	NUT,BLOCK:0.38 X 0.25 X 0.282"OA	80009	220-0547-01
					(ATTACHING PARTS FOR EACH)		
-74	211-0116-00		1	.	SCR,ASSEM WSHR:4-40 X 0.312 INCH,PNH BRS	83385	OBD
					-----*		
-75	384-1148-00		1	.	EXTENSION SHAFT:3.14 L X 0.123 OD,EPOXY-GL	80009	384-1148-00
-76	384-1149-00		1	.	EXTENSION SHAFT:7.0 INCH LONG	80009	384-1149-00
-77	376-0008-00		2	.	CPLG,SHAFT,RIGI:	80009	376-0008-00
-78	210-1018-00		2	.	WASHER,FLAT:0.173 ID X 0.875 OD	80009	210-1018-00
					(ATTACHING PARTS)		
-79	211-0116-00		1	.	SCR,ASSEM WSHR:4-40 X 0.312 INCH,PNH BRS	83385	OBD
					-----*		
	672-0465-00	XB030000	1	.	CKT BOARD ASSY:VERTICAL AMPLIFIER	80009	672-0465-00
-80	-----	B010100 B029999	1	.	CKT BOARD ASSY:INTERFACE(SEE A1 EPL)		
	-----	B030000	1	.	CKT BOARD ASSY:INTERFACE(SEE A1 EPL)		
-81	129-0363-00		2	.	POST,ELEC-MECH:HEX.,0.25 X 0.436 INCH LONG	80009	129-0363-00
					(ATTACHING PARTS FOR EACH)		
-82	211-0116-00		1	.	SCR,ASSEM WSHR:4-40 X 0.312 INCH,PNH BRS	83385	OBD
					-----*		
-83	214-0579-00		2	.	TERM.,TEST PT:BRS CD PL	80009	214-0579-00
-84	131-1030-00		11	.	CONT ASSY,ELEC:CAM SWITCH,BOTTOM	80009	131-1030-00

Fig. & Index No.	Tektronix Part No.	Serial/Model No. Eff	Dscont	Qty	1	2	3	4	5	Name & Description	Mfr Code	Mfr Part Number
1-85	131-1031-00			22	CONTACT ASSY,EL:CAM SWITCH, TOP (ATTACHING PARTS FOR EACH)	80009	131-1031-00
-86	210-0779-00			1	RIVET,TUBULAR:0.051 OD X 0.115 INCH LONG - - - * - - -	42838	RA-29952715
-87	352-0336-00			4	HOLDER,COVER: (ATTACHING PARTS FOR EACH)	80009	352-0336-00
-88	211-0116-00			4	SCR,ASSEM WSHR:4-40 X 0.312 INCH,PNH BRS - - - * - - -	83385	OBD
-89	200-1415-00			2	COVER,CONTACTS:	80009	200-1415-00
-90	131-0589-00			6	TERM,PIN:0.46 L X 0.025 SQ.PH BRZ GL	22526	47350
-91	131-1003-00			3	CONNECTOR BODY,:CKT BD MT,2 PRONG	80009	131-1003-00
-92	136-0252-04	B010100	B033739	67	SOCKET,PIN TERM:0.188 INCH LONG	22526	75060
	136-0252-04	B033740		43	SOCKET,PIN TERM:0.188 INCH LONG	22526	75060
	136-0352-00	B010100	B030000X	4	CONTACT,ELEC:FOR 0.02 INCH DIAMETER PIN	00779	50462-7
-93	136-0235-00	B033740		1	SOCKET,PLUG-IN:6 CONTACT,ROUND	71785	133-96-12-062
-94	136-0220-00	B033740		5	SOCKET,PLUG-IN:3 PIN,SQUARE	71785	133-23-11-034
-95	136-0350-00	B033740		1	SOCKET,PLUG-IN:3 PIN,LOW PROFILE	80009	136-0350-00
-96	214-1797-00	B030000		4	PIN,ATTEN CLIP:	80009	214-1797-00
-97	344-0248-00	B030000		2	CLIP,ATTENUATOR:	80009	344-0248-00
	105-0321-00	B010100	B029999	1	ACTR ASSY,CAM S:INPUT	80009	105-0321-00
	263-1094-00	B030000		1	SW CAM ACTR AS:INPUT	80009	263-1094-00
-98	200-1343-00			1	COVER,CAM SW: (ATTACHING PARTS)	80009	200-1343-00
-99	211-0008-00			4	SCREW,MACHINE:4-40 X 0.25 INCH,PNH STL	83385	OBD
-100	210-0004-00			4	WASHER,LOCK:#4 INTL,0.015THK,STL CD PL - - - * - - -	78189	1204-00-00-0541C
-101	210-0406-00			4	NUT,PLAIN,HEX.:4-40 X 0.188 INCH,BRS	73743	2X12161-402
-102	214-1139-03			1	SPRING,FLAT:RED COLORED	80009	214-1139-03
-103	214-1127-00			1	ROLLER,DETENT:0.125 DIA X 0.125 INCH L	80009	214-1127-00
-104	401-0081-00			1	BEARING,CAM SW:FRONT (ATTACHING PARTS)	80009	401-0081-00
-105	354-0391-00			1	RING,RETAINING:0.395"FREE ID X 0.025" STL - - - * - - -	97464	3100-43-CD
-106	105-0319-00			1	ACTR ASSY,CAM S:INPUT/INVERT	80009	105-0319-00
-107	210-0406-00			4	NUT,PLAIN,HEX.:4-40 X 0.188 INCH,BRS	73743	2X12161-402
-108	401-0146-00			1	BEARING,CAM SW:REAR	80009	401-0146-00
	105-0322-00	B010100	B029999	1	ACTR ASSY,CAM S:INVERT	80009	105-0322-00
	263-1095-00	B030000		1	SW CAM ACTR AS:POLARITY	80009	263-1095-00
-109	200-1343-00			1	COVER,CAM SW: (ATTACHING PARTS)	80009	200-1343-00
-110	211-0008-00			4	SCREW,MACHINE:4-40 X 0.25 INCH,PNH STL	83385	OBD
-111	210-0004-00			4	WASHER,LOCK:#4 INTL,0.015THK,STL CD PL	78189	1204-00-00-0541C
	211-0022-00	B010100	B022299X	2	SCREW,MACHINE:2-56 X 0.188 INCH,PNH STL	83385	OBD
	210-0001-00	B010100	B022299X	2	WASHER,LOCK:INTL,0.092 ID X 0.18"OD,STL - - - * - - -	78189	1202-00-00-0541C
-112	210-0406-00			4	NUT,PLAIN,HEX.:4-40 X 0.188 INCH,BRS	73743	2X12161-402
-113	214-1139-03			1	SPRING,FLAT:RED COLORED	80009	214-1139-03
-114	214-1127-00			1	ROLLER,DETENT:0.125 DIA X 0.125 INCH L	80009	214-1127-00
-115	401-0081-00			1	BEARING,CAM SW:FRONT (ATTACHING PARTS)	80009	401-0081-00
-116	354-0391-00			1	RING,RETAINING:0.395"FREE ID X 0.025" STL - - - * - - -	97464	3100-43-CD
-117	105-0319-00			1	ACTR ASSY,CAM S:INPUT/INVERT	80009	105-0319-00
-118	210-0406-00			4	NUT,PLAIN,HEX.:4-40 X 0.188 INCH,BRS	73743	2X12161-402
-119	401-0146-00			1	BEARING,CAM SW:REAR	80009	401-0146-00
	105-0323-00	B010100	B029999	1	ACTR ASSY,CAM S:VOLTS/DIVISION	80009	105-0323-00
	263-1096-00	B030000		1	SW CAM ACTR AS:VOLTS/DIVISION (ATTACHING PARTS)	80009	263-1096-00
-120	211-0116-00	B010100	B022999	4	SCR,ASSEM WSHR:4-40 X 0.312 INCH,PNH BRS	83385	OBD
	211-0116-00	B023000	B034429	6	SCR,ASSEM WSHR:4-40 X 0.312 INCH,PNH BRS	83385	OBD
	211-0116-00	B034430		4	SCR,ASSEM WSHR:4-40 X 0.312 INCH,PNH BRS	83385	OBD
	211-0180-00	B010100	B022299X	2	SCR,ASSEM WSHR:2-56 X 0.25 INCH,PNH BRS	83385	OBD
-121	211-0062-00	B034430		2	SCREW,MACHINE:2-56 X 0.312 INCH,RDH STL	83385	OBD
-122	210-0053-00			2	WASHER,LOCK:INTL,0.092 ID X 0.175"OD,STL	83385	OBD
-123	210-1008-00	B034430		2	WASHER,FLAT:0.09 ID X 0.188" OD,BRS - - - * - - -	12360	OBD

Replaceable Mechanical Parts—7A19

Fig. & Index No.	Tektronix Part No.	Serial/Model No. Eff	Dscont	Qty	1	2	3	4	5	Name & Description	Mfr Code	Mfr Part Number
1-124	200-1344-00	B010100	B022299	1	COVER, CAM SW:	80009	200-1344-00
	200-1344-01	B022300		1	COVER, CAM SW:	80009	200-1344-01
										(ATTACHING PARTS)		
-125	211-0008-00			6	SCREW, MACHINE:4-40 X 0.25 INCH, PNH STL	83385	OBD
-126	210-0004-00	B010100	B022299	4	WASHER, LOCK:#4 INTL, 0.015THK, STL CD PL	78189	1204-00-00-0541C
	210-0004-00	B022300		5	WASHER, LOCK:#4 INTL, 0.015THK, STL CD PL	78189	1204-00-00-0541C
-127	211-0022-00	B010100	B022299X	2	SCREW, MACHINE:2-56 X 0.188 INCH, PNH STL	83385	OBD
-128	210-0001-00	B010100	B022299X	2	WASHER, LOCK:INTL, 0.092 ID X 0.18"OD, STL	78189	1202-00-00-0541C
-129	210-0007-00	XB023000		1	WASHER, LOCK:#8 EXT, 0.02 THK, STL CD PL	78189	1108-00-00-0541C
										- - - * - - -		
-130	210-0406-00	B010100	B022299	8	NUT, PLAIN, HEX.:4-40 X 0.188 INCH, BRS	73743	2X12161-402
	210-0406-00	B022300	B034429	12	NUT, PLAIN, HEX.:4-40 X 0.188 INCH, BRS	73743	2X12161-402
	210-0406-00	B034430		10	NUT, PLAIN, HEX.:4-40 X 0.188 INCH, BRS	73743	2X12161-402
-131	210-0405-00	XB034430		2	NUT, PLAIN, HEX.:2-56 X 0.188 INCH, BRS	73743	2X12157-402
-132	214-1139-03			1	SPRING, FLAT:RED COLORED	80009	214-1139-03
-133	214-1127-00			1	ROLLER, DETENT:0.125 DIA X 0.125 INCH L	80009	214-1127-00
-134	401-0081-00			1	BEARING, CAM SW:FRONT	80009	401-0081-00
										(ATTACHING PARTS)		
-135	354-0391-00			1	RING, RETAINING:0.395"FREE ID X 0.025" STL	97464	3100-43-CD
										- - - * - - -		
-136	407-0926-00	B010100	B022299	1	BRACKET, COVER:CAM SWITCH, ALUMINUM	80009	407-0926-00
	407-1199-00	B022300		1	BRACKET, COVER:ABS	80009	407-1199-00
-137	105-0320-00			1	DRUM, CAM SWITCH:	80009	105-0320-00
-138	401-0146-00			1	BEARING, CAM SW:REAR	80009	401-0146-00
-139	214-1712-00			1	SPRING, FLAT:GROUNDING	80009	214-1712-00
-140	210-0774-00			4	EYELET, METALLIC:0.152 OD X 0.245 INCH L, BRS	80009	210-0774-00
-141	210-0775-00			4	EYELET, METALLIC:0.126 OD X 0.23 INCH L, BRS	80009	210-0775-00
-142	131-0977-00	B010100	B029999X	1	CONNECTOR, PLUG,:RIGHT ANGLE, MALE	98291	050-028-0000-220
-143	131-0707-00			6	CONNECTOR, TERM.:22-26 AWG, BRS& CU BE GOLD	22526	47439
-144	352-0164-00			1	CONN BODY, PL, EL:6 WIRE BLACK	80009	352-0164-00
-145	175-0829-00			FT	WIRE, ELECTRICAL:6 WIRE RIBBON	08261	SS-0626-710610C

Fig. & Index No.	Tektronix Part No.	Serial/Model No. Eff	Dscont	Qty	1	2	3	4	5	Name & Description	Mfr Code	Mfr Part Number
2-1	366-1023-01			1						KNOB:GRAY	80009	366-1023-01
-2	333-1544-00			1						PANEL,FRONT:	80009	333-1544-00
-3	354-0425-00			1						RING,INDICATOR:	80009	354-0425-00
-4	401-0150-00			1						GEAR,SPUR:DRIVE,10 TOOTH	80009	401-0150-00
-5	384-0827-00			1						SHAFT,STRAIGHT:	80009	384-0827-00
-6	380-0271-00			1						HOUSING,IND:INNER	80009	380-0271-00
-7	380-0270-00			1						HOUSING,IND:OUTER	80009	380-0270-00
-8	376-0029-00			1						CPLG,SHAFT,RGD:0.128 ID X 0.312 OD X 0.5"L	80009	376-0029-00
-9	354-0163-00			1						RING,RETAINING:TRUARC,CAD PLATE	79136	5133-12MD
-10	407-1015-00			1						BRACKET,ANGLE:VAR DELAY LINE,ALUMINUM (ATTACHING PARTS)	80009	407-1015-00
-11	211-0007-00			2						SCREW,MACHINE:4-40 X 0.188 INCH,PNH STL	83385	OBD
-12	210-0054-00			2						WASHER,LOCK:SPLIT,0.118 ID X 0.212"OD STL	83385	OBD
-13	211-0101-00			2						SCREW,MACHINE:4-40 X 0.25" 100 DEG,FLH STL	83385	OBD
										- - - * - - -		
-14	119-0321-00			1						DELAY LINE,ELEC:	80009	119-0321-00
-15	200-1315-00	B010100	B019999	1						. COVER,DLY LINE:	80009	200-1315-00
	200-1315-01	B020000		1						. COVER DLY LINE:	80009	200-1315-01
-16	211-0038-00	B010100	B019999	9						. SCREW,MACHINE:4-40 X 0.312"100 DEG,FLH STL	83385	OBD
	211-0038-00	B020000		11						. SCREW,MACHINE:4-40 X 0.312"100 DEG,FLH STL	83385	OBD
-17	352-0294-00			4						. HOLDER,DLY LINE:	80009	352-0294-00
-18	352-0295-00			4						. HOLDER,DLY LINE:	80009	352-0295-00
-19	352-0297-00			1						. HOLDER,DLY LINE:	80009	352-0297-00
-20	200-1311-00			2						. CAP,DRIVE BLOCK:	80009	200-1311-00
-21	391-0095-00			2						. GEAR RACK:	80009	391-0095-00
-22	119-0315-00			1						. DELAY LINE,ELEC:	80009	119-0315-00
-23	119-0314-00			2						. DELAY LINE,ELEC:	80009	119-0314-00
-24	119-0316-00	B010100	B019999	2						. DELAY LINE,ELEC:	80009	119-0316-00
-25	401-0148-00			2						. SUPPORT SHAFT:	80009	401-0148-00
-26	384-0895-00			1						. SHAFT,STRAIGHT:	80009	384-0895-00
-27	214-0966-00			1						. SPRING,HLCPS:	80009	214-0966-00
	131-0850-00	B010100	B019999	2						. CONN,FEEDTHRU:3MM FEMALE EAEND	000CN	2084-0000
-28	103-0156-00	B010100	B019999	2						. JACK,TIP:	80009	103-0156-00
	131-1304-00	B020000		2						. CONN,PLUG,ELEC:	80009	131-1304-00
-29	380-0267-00	B010100	B019999	1						. HSG,DELAY LINE:ALUMINUM	80009	380-0267-00
	380-0267-01	B020000		1						. HSG,DELAY LINE: (ATTACHING PARTS FOR DELAY LINE)	80009	380-0267-01
-30	211-0106-00			2						SCREW,MACHINE:4-40 X 0.625"100 DEG,FLH,STL	83385	OBD
										- - - * - - -		
	131-0888-00	B010100	B019999	2						CONNECTOR,PLUG,:MALE	26805	2031-5006-95
	131-0977-00	B010100	B019999X	1						CONNECTOR,PLUG,:RIGHT ANGLE,MALE	98291	050-028-0000-220
-31	210-0774-00	B010100	B019999	1						EYELET,METALLIC:0.152 OD X 0.245 INCH L,BRS	80009	210-0774-00
	210-0774-00	B020000		3						EYELET,METALLIC:0.152 OD X 0.245 INCH L,BRS	80009	210-0774-00
	210-0775-00	B010100	B019999	1						EYELET,METALLIC:0.126 OD X 0.23 INCH L,BRS	80009	210-0775-00
	210-0775-00	B020000		3						EYELET,METALLIC:0.126 OD X 0.23 INCH L,BRS	80009	210-0775-00

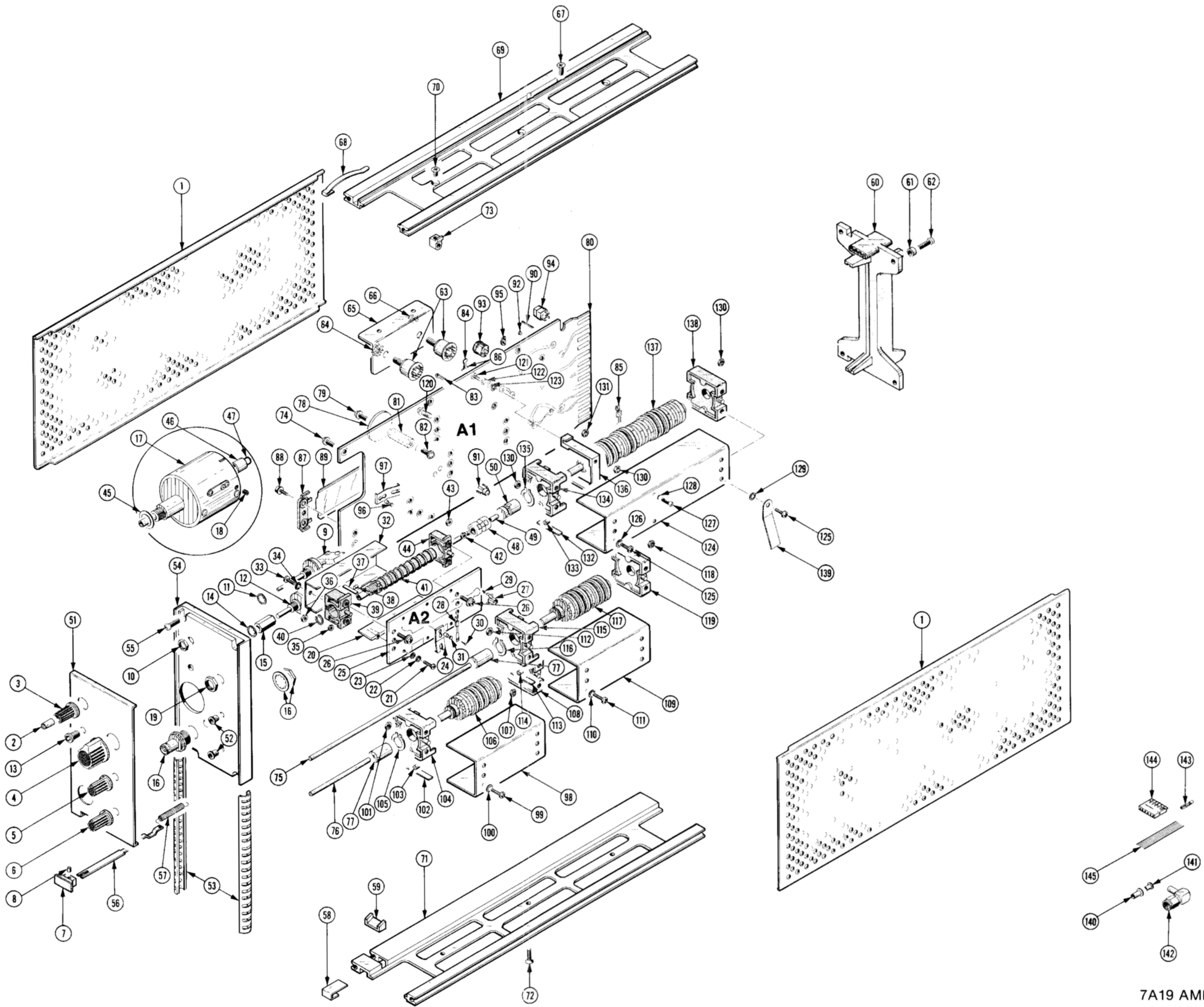

7A19 AMPLIFIER

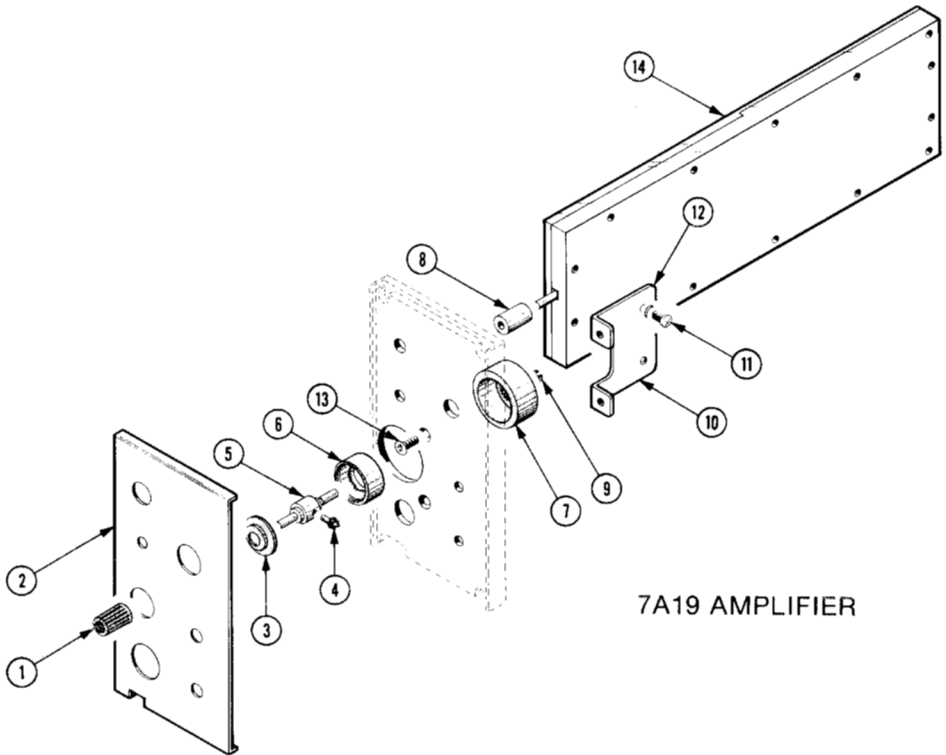

7A19 AMPLIFIER

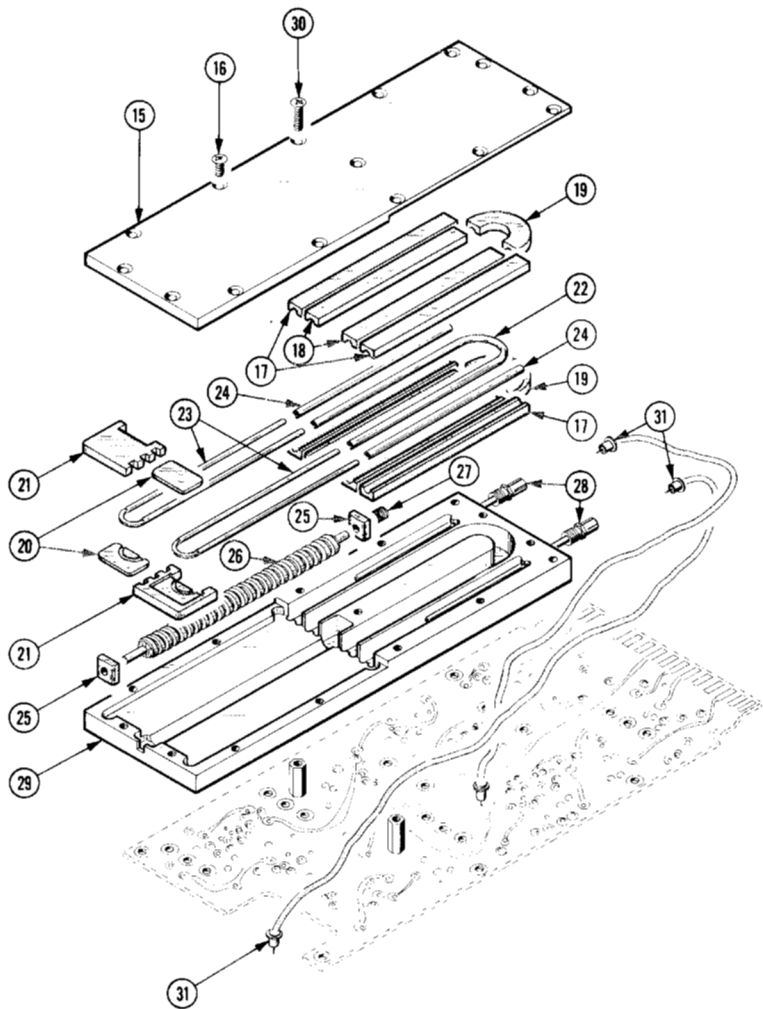

Fig. & Index No.	Tektronix Part No.	Serial/Model No. Eff	No. Dscont	Qty	1	2	3	4	5	Name & Description	Mfr Code	Mfr Part Number
	070-2129-00			1						MANUAL, TECH: INSTRUCTION	80009	070-2129-00

MANUAL CHANGE INFORMATION

At Tektronix, we continually strive to keep up with latest electronic developments by adding circuit and component improvements to our instruments as soon as they are developed and tested.

Sometimes, due to printing and shipping requirements, we can't get these changes immediately into printed manuals. Hence, your manual may contain new change information on following pages.

A single change may affect several sections. Since the change information sheets are carried in the manual until all changes are permanently entered, some duplication may occur. If no such change pages appear following this page, your manual is correct as printed.

SERVICE NOTE

Because of the universal parts procurement problem, some electrical parts in your instrument may be different from those described in the Replaceable Electrical Parts List. The parts used will in no way alter or compromise the performance or reliability of this instrument. They are installed when necessary to ensure prompt delivery to the customer. Order replacement parts from the Replaceable Electrical Parts List.

CALIBRATION TEST EQUIPMENT REPLACEMENT

Calibration Test Equipment Chart

This chart compares TM 500 product performance to that of older Tektronix equipment. Only those characteristics where significant specification differences occur, are listed. In some cases the new instrument may not be a total functional replacement. Additional support instrumentation may be needed or a change in calibration procedure may be necessary.

Comparison of Main Characteristics

DM 501 replaces 7D13		
PG 501 replaces 107 108	PG 501 - Risetime less than 3.5 ns into 50 Ω. PG 501 - 5 V output pulse; 3.5 ns Risetime	107 - Risetime less than 3.0 ns into 50 Ω. 108 - 10 V output pulse 1 ns Risetime
PG 502 replaces 107 108 111	PG 502 - 5 V output PG 502 - Risetime less than 1 ns; 10 ns Pretrigger pulse delay	108 - 10 V output 111 - Risetime 0.5 ns; 30 to 250 ns Pretrigger pulse delay
PG 508 replaces 114 115 2101	Performance of replacement equipment is the same or better than equipment being replaced.	
PG 506 replaces 106 067-0502-01	PG 506 - Positive-going trigger output signal at least 1 V; High Amplitude output, 60 V. PG 506 - Does not have chopped feature.	106 - Positive and Negative-going trigger output signal, 50 ns and 1 V; High Amplitude output, 100 V. 0502-01 - Comparator output can be alternately chopped to a reference voltage.
SG 503 replaces 190, 190A, 190B 191 067-0532-01	SG 503 - Amplitude range 5 mV to 5.5 V p-p. SG 503 - Frequency range 250 kHz to 250 MHz.	190B - Amplitude range 40 mV to 10 V p-p. 0532-01 - Frequency range 65 MHz to 500 MHz.
SG 504 replaces 067-0532-01 067-0650-00	SG 504 - Frequency range 245 MHz to 1050 MHz.	0532-01 - Frequency range 65 MHz to 500 MHz.
TG 501 replaces 180, 180A 181 184 2901	TG 501 - Trigger output-slaved to marker output from 5 sec through 100 ns. One time-mark can be generated at a time. TG 501 - Trigger output-slaved to market output from 5 sec through 100 ns. One time-mark can be generated at a time. TG 501 - Trigger output-slaved to marker output from 5 sec through 100 ns. One time-mark can be generated at a time.	180A - Trigger pulses 1, 10, 100 Hz; 1, 10, and 100 kHz. Multiple time-marks can be generated simultaneously. 181 - Multiple time-marks 184 - Separate trigger pulses of 1 and 0.1 sec; 10, 1, and 0.1 ms; 10 and 1 μs. 2901 - Separate trigger pulses, from 5 sec to 0.1 μs. Multiple time-marks can be generated simultaneously.

NOTE: All TM 500 generator outputs are short-proof. All TM 500 plug-in instruments require TM 500-Series Power Module.

CHANGE	DESCRIPTION
TEXT CORRECTIONS	
SECTION 2 OPERATING INSTRUCTIONS	
Page 2-2	Vertical Gain Check and Adjustment First sentence of the paragraph
CHANGE TO:	
To check the gain of the 7A19, set the VOLTS/DIV switch to 10 mV and connect 20 mV (into 50 ohm), 1 kHz signal from the oscilloscope Calibrator to the INPUT connector.	
SECTION 5 CALIBRATION	
Page 5-2	Test Equipment Item 4-Minimum Specifications
CHANGE TO:	
Amplitude accuracy within 0.25%; range, 50 mV to 2 V into 50 ohm; frequency, 1 kHz.	
Page 5-5	Step 5, Temperature Compensation Adjust, part a.
CHANGE TO:	
a. Connect a 1kHz, 0.2 V (into 50 ohm) square-wave signal from the oscilloscope Calibrator to the 7A19 INPUT using a 42 inch BNC cable.	
Page 5-5	Step 6, GAIN Check/Adjust, part b, c and d.
CHANGE TO:	
b. Set the Standard Amplitude Calibrator for a 50 mV square-wave output and set the Input Coupling switch to DC.	
c. Check-CRT display for a vertical deflection of five divisions ± 0.15 division.	
d. Adjust-Front panel GAIN control for exactly five divisions vertical deflection.	